

**SUPERVISOR 5000  
(SU5000)**

**Optical Turnstile with Bi-directional Motorized Barriers**

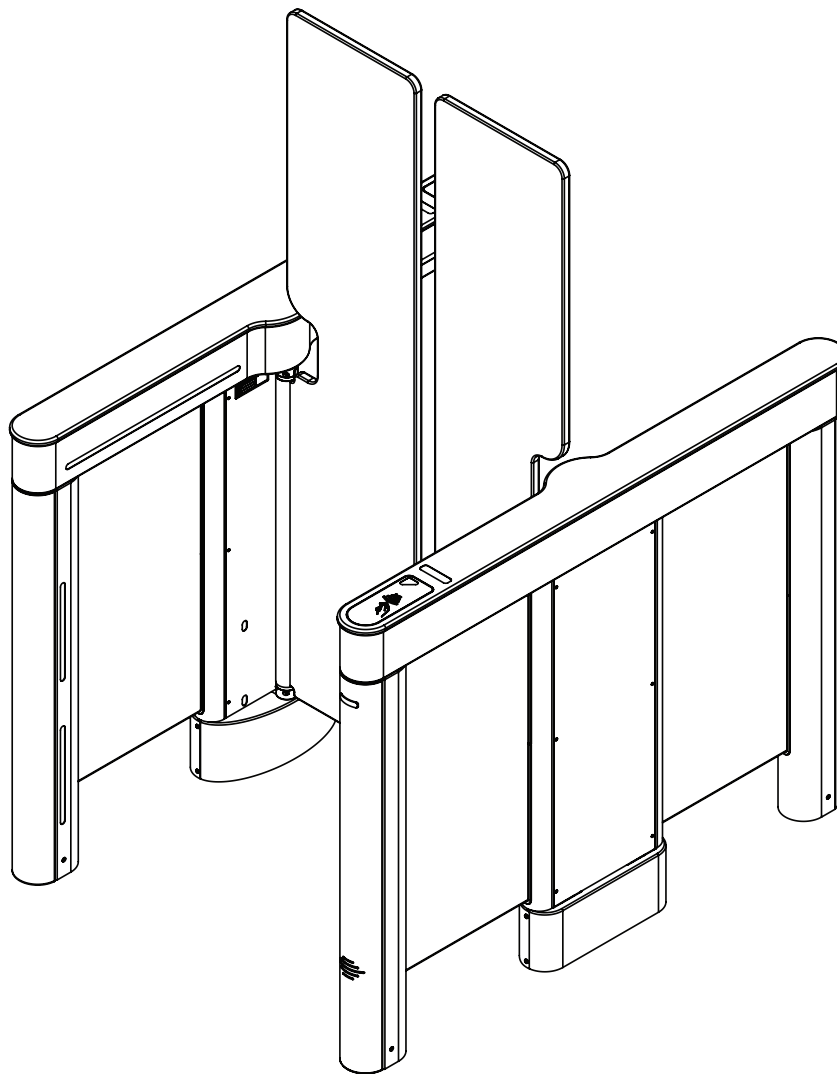

**User Guide**

---

**Alvarado Manufacturing Company, Inc.**

12660 Colony Street, Chino, CA 91710

Phone: +1 (909) 591-8431

Fax: +1 (909) 628-1403

support@alvaradomfg.com

www.alvaradomfg.com



This page intentionally left blank.



## Contents

Contents.....	3
ETL Certification.....	3
Safety Precautions.....	4
Purpose Of This User Guide.....	5
Intended Users.....	5
User Responsibilities.....	5
SU5000 Overview.....	6
SU5000 Components - Exterior View.....	6
SU5000 Components - Center Portion Interior View.....	8
SU5000 Cabinets.....	10
SU5000 Options.....	13
Access Control Integration.....	14
SU5000 Functionality.....	15
Passage Modes.....	15
Setting Passage Modes.....	16
Bi-directional Traffic and Smart Use of Passage Modes.....	16
User Status Display.....	18
Open / Close Status Light.....	19
Operational Sounds.....	20
SU5000 Operation.....	22
Powering On / Off.....	22
Lane Key Control (Option).....	23
User Instructions.....	24
Turnstile Operations.....	26
I/O Control.....	32
Inputs.....	32
Outputs.....	35
SU5000 Configuration Preparation.....	38
Overview.....	38
New Installation Configuration Checklist.....	38
Installing the Configuration Tools.....	39
Connecting a Laptop Directly to the Turnstile.....	40
Operating System Configuration.....	41
Setting the Local System Time.....	43
Setting the Turnstile IP Address.....	44
Maintenance.....	46
Weekly Safety Check.....	47
Troubleshooting.....	48
Revision History.....	50

## ETL Certification



This product is fully certified by a nationally recognized testing laboratory to UL 2593 and CSA C22.2 #247. Unauthorized modification to this product in any way is prohibited.



## Safety Precautions



### WARNING

The Supervisor 5000 may present a risk to persons and property if it is not operated correctly. Therefore, this manual must be read in its entirety and all safety and operations information must be adhered to. Note the following precautions:

- For indoor use only.
  - Use only skilled individuals to install and service the turnstile.
  - DO NOT operate the turnstile if it has been damaged in any manner. If damaged, have the unit repaired or adjusted by a skilled service person before use.
  - DO NOT modify or alter the turnstile.
  - Have skilled individuals maintain the turnstile according to a proper maintenance schedule.
  - In access control applications, train all personnel that will be using the turnstile in the proper method of operation. In addition, properly train new users as they are added to the system.
  - DO NOT use non-Alvarado parts to repair a damaged turnstile.
  - Power off the turnstile before connecting or disconnecting any communication or power wiring to the turnstile.
  - This turnstile can be used by children aged 12 and above, inexperienced persons, or persons with reduced physical, sensory, or mental conditions, if such children or persons are supervised, or have been provided instruction regarding the safe and proper usage. Children shall not play with or around the turnstile.
  - The turnstile shall be disconnected from its power source during service and when replacing parts. The turnstile shall be disconnected from its power source before connecting or disconnecting any communication or other activation/feedback control wires. If it is not possible that the technician can check from any point to which he has access that the main power is removed, a disconnection with a locking system in the isolated position shall be provided.
- 
- Pour utilisation à l'intérieur seulement.
  - Utilisez uniquement des personnes qualifiées pour installer et entretenir le tourniquet.
  - NE PAS faire fonctionner le tourniquet s'il a été endommagé de quelque façon. S'il est endommagé, faire réparer ou ajuster l'unité avant l'utilisation par un(e) préposé(e) à l'entretien qualifié(e).
  - NE PAS modifier ou altérer le tourniquet.
  - Le tourniquet doit être maintenu selon un calendrier d'entretien adéquat par des personnes qualifiées.
  - Dans les applications de contrôle d'accès, former tout le personnel qui utilisera le tourniquet selon la bonne méthode de fonctionnement. De plus, bien former les nouveaux utilisateurs à leur intégration au système.
  - NE PAS utiliser des pièces ne provenant pas du Alvarado pour réparer un tourniquet endommagé.
  - Suivez strictement les instructions de manutention pour déplacer ou soulever le tourniquet lors de l'installation
  - Éteignez le tourniquet avant de brancher ou de débrancher le câblage de communication ou le câblage d'électricité.



## Purpose Of This User Guide

The Supervisor 5000 (“SU5000”) User Guide is an operational manual which describes the operational features of Alvarado SU5000 optical turnstile product.

## Intended Users

The manual is intended for use by owners, facility operators, and system integrators responsible for the product, the facility access system and the employees, vendors and invitees that will use the equipment on a day-to-day basis.

## User Responsibilities

As owner or caretaker of the equipment, it is essential that you maintain your SU5000s and ensure safe product use by the employees, vendors, and invitees that will be utilizing the product.

The operation of the SU5000s should be tested weekly to ensure the product is operating correctly. This User Guide provides instructions for a Weekly Safety Check.



## SU5000 Overview

The SU5000 is an optical turnstile that provides bi-directional access control in conjunction with a facility access control system. The SU5000 utilizes tandem motorized barriers and integrated optical sensors to control access. The optical sensors detect patrons, determine the direction of patron movement, and detect both authorized and unauthorized users.

## SU5000 Components - Exterior View

An overview of the major turnstile components is presented below [Fig. 1 & Fig. 2]. More information on these components can be found later in the User Guide.

**Fig. 1** SU5000 Components - Exterior View

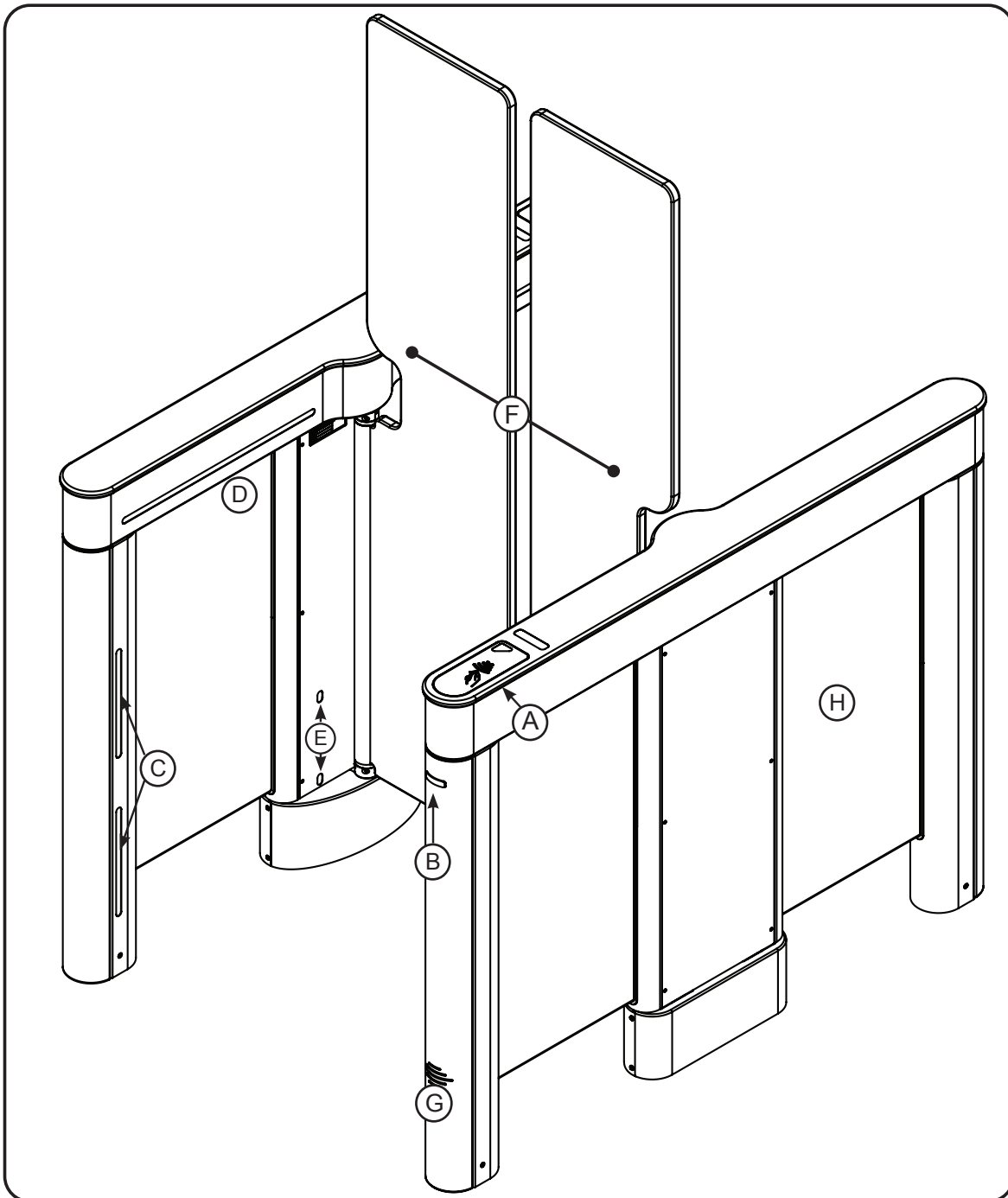



## SU5000 Components - Exterior View (cont.)

### (A) User Status Display / Card Reader Location

The user status display provides visual instructions to users regarding the status of presented credentials (based on data from the access control system) and visual notification of alarm conditions.

Card readers are normally installed underneath the lid directly below the user status display.

### (B) Open / Closed Status Light

Open / closed status lights are mounted to the right-hand leg for each direction of entry. The lights function similar toll booth lights, and notify the user of turnstile availability status.

### (C) Free Passage Sensors

Free passage sensors are located on both ends of the turnstile in the area indicated. Infrared transmitters are on the secondary side of the turnstile. Infrared receiver sensors are on the Main side of the turnstile.

In Free Pass mode, these sensors detect users as soon as they enter the turnstile, triggering the barriers to open away from the user.

### (D) Operational Sensors

Operational sensors are located inside the top channel of the cabinet, running horizontally the length of the cabinet. Infrared transmitters are on the secondary side of the turnstile. Infrared receiver sensors are on the Main side of the turnstile.

Operational sensors have multiple purposes. These include the detection and monitoring of users as they enter, pass through and exit the turnstile, and the detection of objects in the path of opening barriers.

### (E) Safety Sensors

Safety Sensors are located in the center portion of the cabinet on both the entry and exit side of the turnstile. Infrared transmitters are on the secondary side of the turnstile. Infrared receiver sensors are on the Main side of the turnstile. Safety sensors are used to prevent the barriers from opening and closing on a user.

### (F) Motorized Barriers

The motorized moving barriers are acrylic with a special abrasion resistant coating. Barriers are offered in three heights: 35", 46" or 69". The barriers operate bi-directionally. Movement of the barriers is accomplished through the integration of brushless DC motors, digital position encoders, motor controllers and motor control software using closed loop position control.

### (G) Speaker

A speaker is mounted to each leg of Main and center cabinets. The speaker is used to play auditory sounds and alarms.

### (H) Side Panels

Side Panels are acrylic with a special abrasion resistant coating.



# SU5000 Components - Center Portion Interior View

**Fig. 2** Center Portion Interior (Main Cabinet)

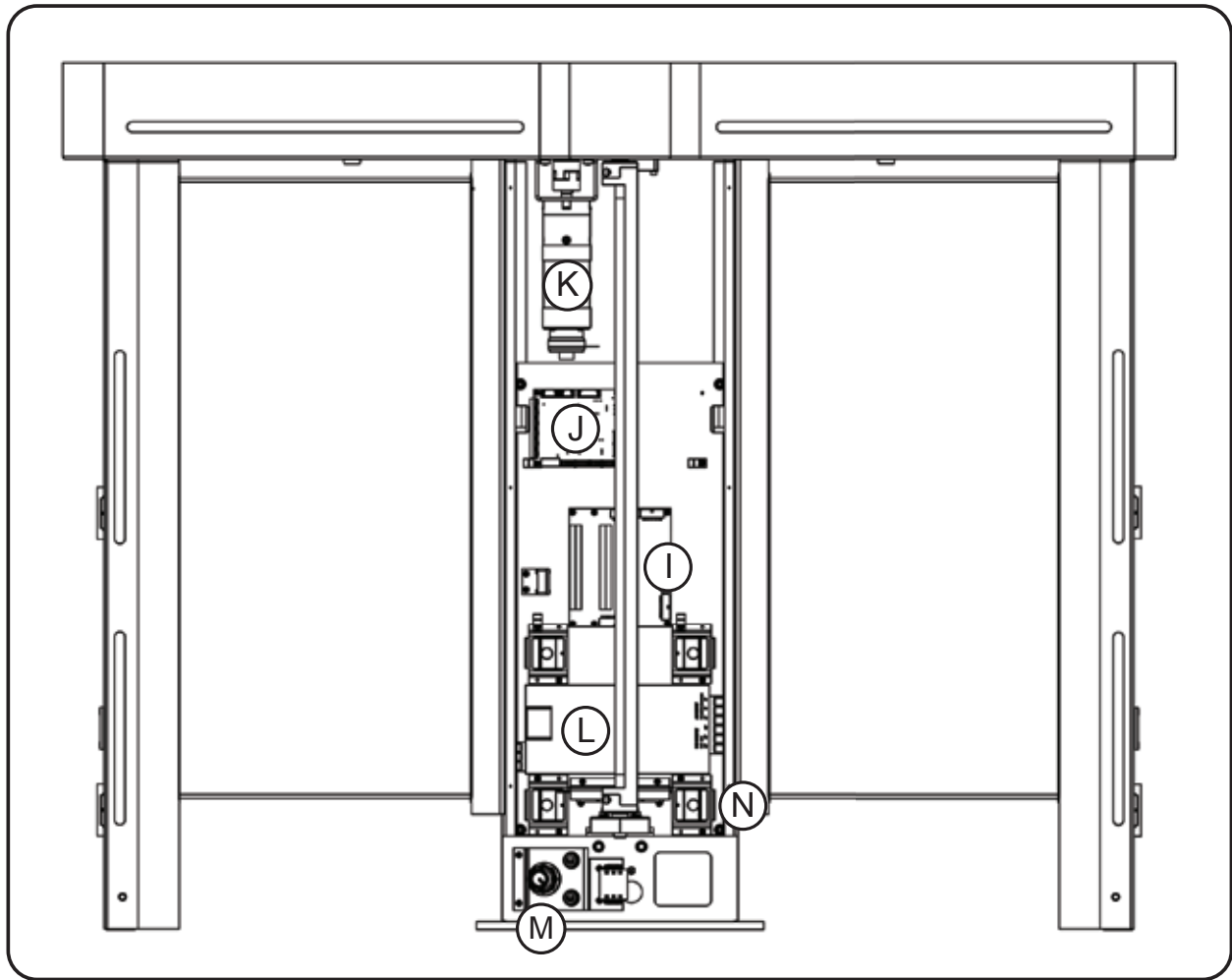





## SU5000 Components - Center Portion Interior View (cont.)

### I Main Turnstile Controller & I/O Control Board

There is one CPU and one I/O control board per turnstile. The two boards are stacked inside the Main cabinet. The I/O control board is the outward most accessible board and is the interface point between the turnstile and the facility access control system. Passage activation and the various other inputs and outputs available from the turnstile are accessed through the I/O control board terminal strips. The main turnstile controller houses the CPU unit and various hardware ports, such as USB, Ethernet, and HDMI.

### J Motor Controller Board

Each turnstile has two motor controller boards. Each motor controller board controls one of the two turnstile motors. Low-voltage power and various data signals are also routed through motor controller boards.

### K Motors

Each turnstile has two brushless DC motors (combined with planetary gearbox and electro-mechanical brake) that operate the drive system moving the barriers.

### L Power Supply

There is a single 24V power supply installed in the Main / Center cabinet. This supply converts primary power to 24V low-voltage power for motor operation. Motor controller boards reduce the 24V power to 5V and 12V for main turnstile controller, optical sensor, and light operation.

### M Power Switch

There is one power switch installed per turnstile. The power switch is installed in the base of the Main / Center cabinet on the secured side.

### N Safety Sensors

There are four safety sensors per cabinet.



## SU5000 Cabinets

There are three types of SU5000 cabinets used to create passage lanes: a Main Cabinet, a Secondary Cabinet, and a Center (Expansion) cabinet. A single passage lane consists of a Main cabinet and a Secondary cabinet [Fig. 3]. The Center cabinet is used to create additional passage lanes with the addition of a single cabinet [Fig. 4].

Each cabinet has an unsecured and secured side. Alvarado follows what we call the “right-hand rule.” User status lights and card readers are always installed on the right-hand side as you enter the turnstile.

### Main Cabinet

The center portion of the Main Cabinet contains the turnstile CPU, I/O control board, motor and motor controller board, power supply, safety sensor receivers, one moving barrier, and a power switch located at the base on the secured side.

The top channel of the Main Cabinet contains the operational sensor receivers, a drive system, and a User Status Display that communicates turnstile status to the user. A card reader is normally installed during installation underneath the lid below the User Status Display.

### Secondary Cabinet

The center portion of the Secondary Cabinet contains a motor and motor controller board, safety sensor transmitters, and one moving barrier.

The top channel of the Secondary Cabinet contains the sensor transmitters, a drive system, and a User Status Display that communicates turnstile status to the user. A card reader is normally installed during installation underneath the lid below the User Status Display.

**Fig. 3** Single Lane Configuration

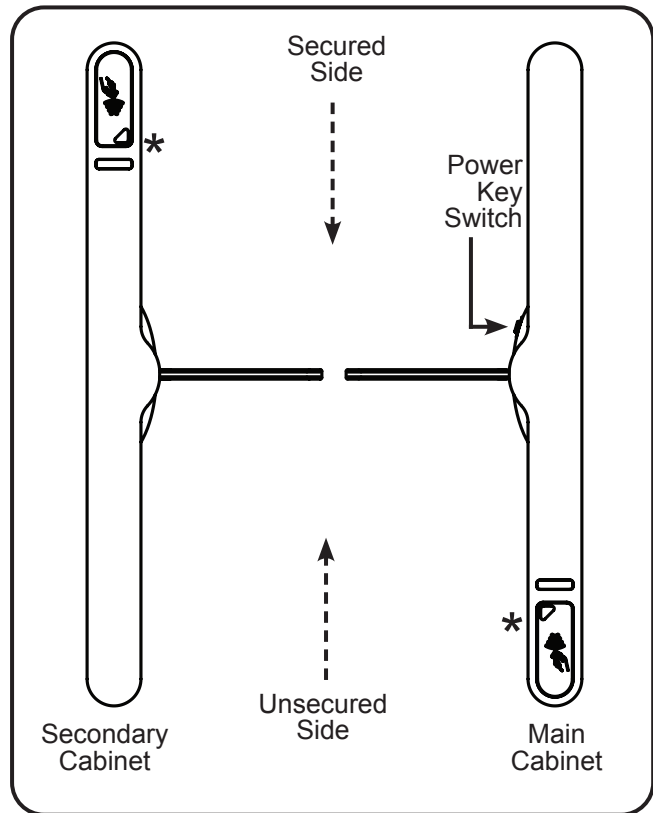

\* Normal positions for card readers located under the user status display.



# SU5000 Cabinets (cont.)

## Center Cabinet (Multi-Lane Configuration)

Center cabinets contain both Main and Secondary components. Center cabinets are extension cabinets used in multi-lane applications. An unlimited number of center cabinets can be added.

The center portion of the center cabinet contains the CPU, I/O control board, two motors and two motor controller boards, power supply, safety sensors for both the Main and Secondary side of the center cabinet, two moving barriers, and a power switch located at the base on the secured side of the Main side.

The top channel of the center cabinet contains Main and Secondary side operational sensors, two drive systems, and two user status displays that communicate turnstile status to the user. Two card readers are normally installed during installation underneath the lid below the user status display on both sides of the center cabinet top channel.

**Fig. 4** Multi-Lane Configuration

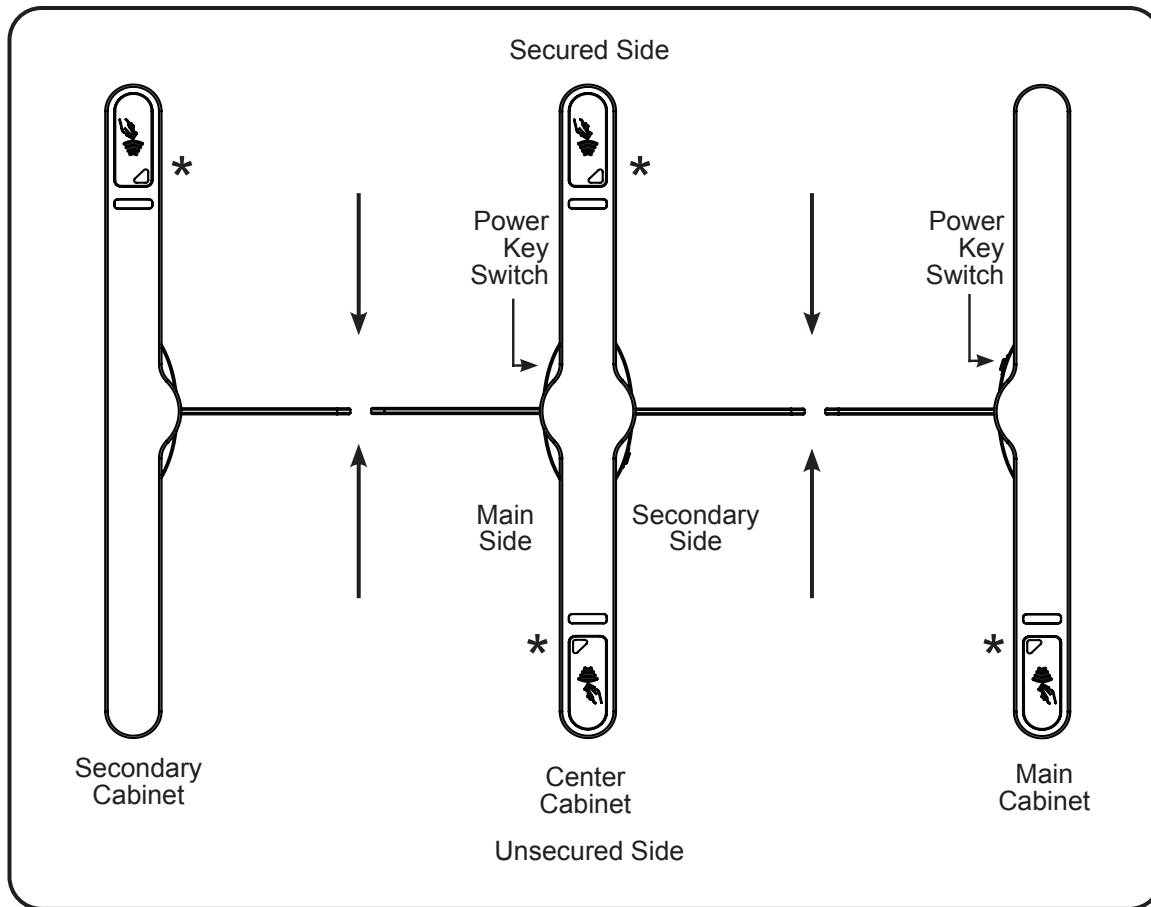

\* Normal positions for card readers located under the user status display.



## SU5000 Cabinets (cont.)

### Center Cabinet (Combination 36" & 28" Widths)

SU5000 cabinets can be equipped with different sized barrier widths to create both 28" and 36" lanes. [Fig. 5] shows a multi-lane configuration with a 36" passage width on left and 28" passage width on right.

**Fig. 5** Multi-Lane Configuration (36" & 28" Widths)

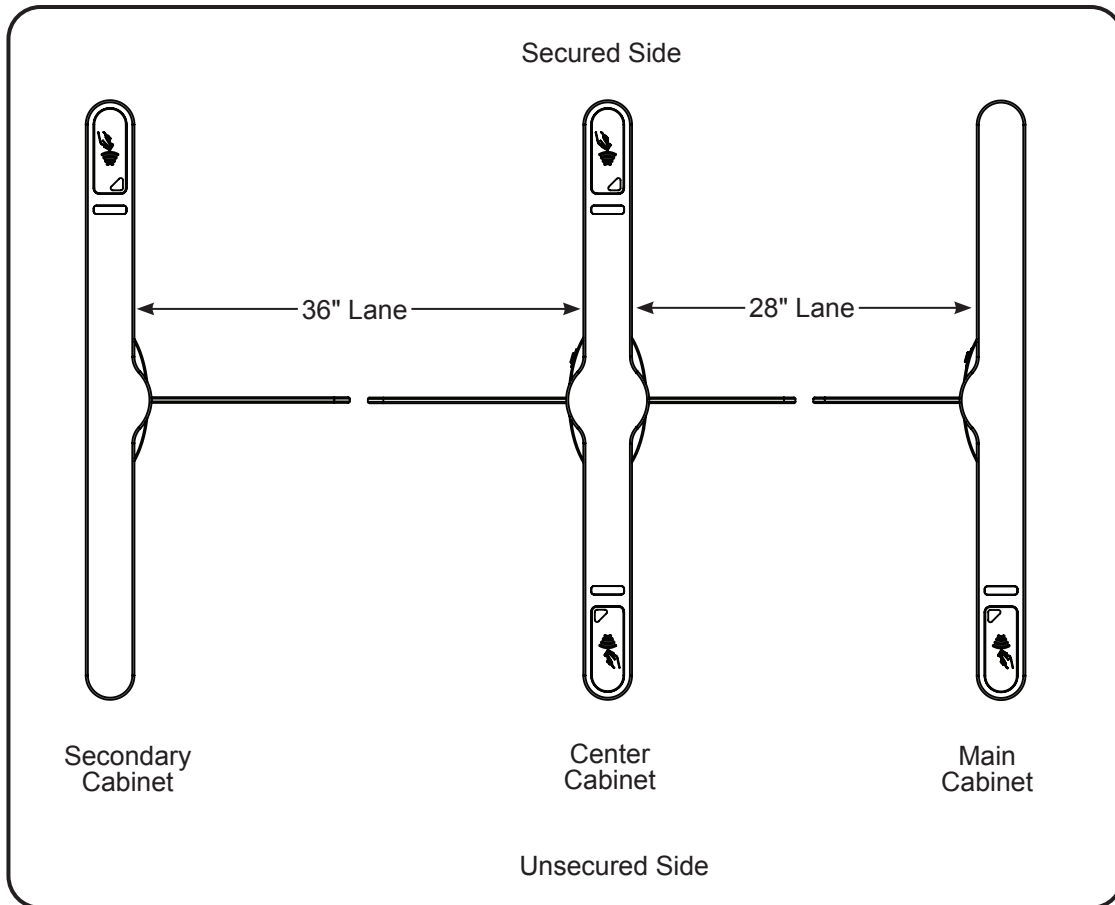



## SU5000 Options

There are various SU5000 options. Options relating to turnstile operation are listed below:

### Alternate Lid Colors and Materials

Lids can be provided in any available solid surface color. Lids with a laser cut stainless steel inlay with a solid surface frame can be provided. Select alternate materials are also available.

### Alternate Power Supply

A 220 - 240 VAC, 50 Hz power supply and appropriately rated key switch are utilized.

### Automatic Barrier Opening on Loss of Power

An enclosure houses the turnstile UL listed power supply and power buffer. On loss of power, the power buffer retains power to automatically open the barriers in the exit direction.

### Barcode Reader for Visitor Identification

A 1D/2D barcode reader is installed on either or both sides of the turnstile. The barcode reader is installed into the right-hand leg of the turnstile (scanner facing down). Users present credentials into a recessed area located below the open / close status light. Barcode readers are generally used for visitor identification in conjunction with an access control or visitor management solution. Barcode readers are supplied with an RS232 serial or Wiegand output (using an RS232 serial to Wiegand converter).

### Barrier Height

Moving barriers are available in low (35"), mid (46") and high (69") heights. Low and mid-height barriers are 0.5" (13mm) thick. High (69") barriers are 0.75" (19mm) thick.

### Barrier & Side Panel Etching

Customer's choice of logo / artwork may be etched on the clear moving barriers and / or clear side panels.

### Baseplate

A baseplate for either single lane or multi-lane configurations is available. The baseplate is powder coated black with a black non-slip coating in the passageway area. The baseplate includes enclosed cable runs and eliminates the need for trenching or stubbing up conduit from the floor.

### Card Reader Integration

Card readers up to 1.75" H x 3.6" W x 6.7" L (44mm x 91mm x 170mm) can be used with the SU5000. Custom reader integration is available. If you are utilizing larger sized readers, this will have been addressed during the ordering and product checklist process.

### Climb Over Detection

Load cells are installed underneath the lid to detect an unauthorized user attempting to climb on the lid to gain entry.



## SU5000 Options (cont.)

### Custom Cabinets

External cabinet materials may be powder coated or plated in a variety of finishes.

### Longer Interconnect Cables

Among the cabling requirements for the SU5000 is an "interconnect cable" that runs through conduit between the two turnstile cabinets. The standard interconnect cable length is 8'. Longer interconnect cables, available in 13', 20' and 40' lengths, are available on a custom order basis.

### Power Supply - External Enclosure

A portable enclosure houses the Supervisor 5000s' primary power supply. The enclosure house up to three (3) power supplies (one power supply is required per Supervisor 5000 turnstile). Conduit entry / exit ports are provided for connecting 110 / 220VAC primary power to the power supplies and running 24VDC power to the turnstiles. The low-voltage wire run should not exceed 100' using the specified wire guage (contact Alvarado for additional information).

### Side Panel Illumination (Static)

Side panels may be illuminated via low-voltage LEDs in one of the following colors: white, green, blue, and red. The panels are constantly illuminated with the selected color when the turnstile is powered.

### Side Panel Illumination (Dynamic)

Dynamic Side Panel Illumination combines static side panel illumination with dynamic changes to the lighting of the side panel on the right-hand side of the turnstile (directly underneath the user status display). Depending on the turnstile status, the side panel changes color in coordination with the user status display. The dynamic side panel illumination option allows an attendant to visually identify the status of a presented credential and quickly identify a turnstile with an alarm condition. Colors used with dynamic side panel illumination are blue (static), green ("good" card) and red ("bad" card and alarm conditions).

### Split Crossover Cable

A crossover cable meant for situations where the standard 1.5" conduit cannot be used. This cable allows the use of a 3/4" conduit for the crossover cable.

### Turnstile Lane Key Control

Two 3-position key switches are installed on the turnstile to control passage modes for both directions of travel. Turning the key to one of three positions overrides all existing settings, placing the turnstile in Controlled Passage, Free Passage, or No Passage modes depending on the orientation of the key.

### GateKeeper

GateKeeper is an optional web-based application that allows Alvarado optical turnstiles installed to be controlled from multiple devices including desktops, tablets, mobile devices, and integrated touch screens. GateKeeper allows the control and scheduling of most day-to-day operating functions including designating a turnstile as entry or exit only, opening or closing a turnstile, and allowing single passage overrides for guests or personnel that have forgotten their access card. The application also includes various other functions. These functions include an emergency "open all turnstiles" capability that is in addition to the emergency override / fire alarm capabilities of the SU5000. The application has tiered login levels with three levels of security (Operator, Supervisor, and Administrator).



## Access Control Integration

There are two types of interfaces to allow an access control system to operate with the SU5000:

### Dry Contacts

Single passage activation and the various other inputs and outputs available to / from the SU5000 are accessed through the I/O control board located in the Main cabinet. The required system input to the SU5000 is a voltage free, momentary dry contact (unless otherwise indicated). Outputs to the SU5000 are also voltage-free, momentary dry contacts. In rare cases, depending on the access control system, it may be desirable to utilize isolation relays to ensure proper system signaling. Additional information on I/O interfacing is provided later in this manual.

### TCP/IP

For select projects, a TCP/IP interface is available. This interface allows a third party access system to communicate to / from the SU5000 using a defined TCP/IP command structure. There is an additional charge for use of the TCP/IP interface and implementation requires programming efforts on the part of the access system provider. Instructions pertaining to the TCP/IP interface is outside the scope of this manual.

## SU5000 Functionality

### Passage Modes

Entry and exit directions can be individually configured to different passage modes to suit facility requirements. For example, a turnstile can be configured for Controlled Passage mode in the entry and exit directions, or Controlled Passage mode in the entry direction and Free Passage mode in the exit direction. The turnstile may also be configured to any combination of the passage modes listed below.

The various passage modes are described below.

#### Controlled Passage Mode

In Controlled Passage mode, the barriers are closed, securing the turnstile. Upon receipt of an authorization signal from an access control system the barriers move away from the user to the open position, allowing a single passage in the authorized direction. The barriers will close after the user has passed through the turnstile, or if no passage occurs after activation, after the entry access time (6 second default) has expired.

#### Free Passage Mode

In Free Passage mode, an access control authorization signal is not required for a user to pass through the turnstile. Barriers are closed until a user enters the turnstile in the Free Passage mode direction, at which time the barriers automatically open in the direction of travel. The barriers will close after the user has passed through the turnstile, or if no passage occurs after activation, after the entry access time (6 second default) has expired.

#### No Passage Mode

No passage is allowed. The barriers are closed and remain closed. Valid electronic credentials are ignored and passage is not allowed. The barriers will still open in the exit direction (toward the unsecured side) if a fire alarm input is received.

#### Visitor Passage Mode

Visitor Passage mode places the turnstile in Free Passage mode and disables the barriers in both the entry and exit directions. The purpose of this mode is to allow a group of non-credentialed visitors to enter and leave the facility without requiring an attendant to enter individual authorizations for each person. Typically, Visitor Passage mode is enabled / disabled with the use of a toggle button at a security desk.



## Setting Passage Modes

Turnstile Passage Modes can be set in one of three ways:

### Turnstile Lane Key Control

If this option has been ordered for your turnstiles, two 3-position key switches are installed on the turnstile. Turning the key to one of the three positions allows each turnstile direction to be placed in any of the passage modes. Instructions on using lane key control are provided on Page 23.

### I/O Control Board

Passage Modes are set via wiring to the I/O control board inputs. This method is ideal for facilities that do not require changing passage mode configurations throughout the day. This is the most common method used by our customers. Instructions for wiring to the I/O control board are provided in the *SU5000 Installation Instructions*.

### GateKeeper

GateKeeper is an optional web-based application. GateKeeper, along with other functionality, allows the passage modes for both the entry and exit side of the turnstiles to be changed. Instructions on configuring passage modes using GateKeeper is outside the scope of this manual.

## Bi-directional Traffic and Smart Use of Passage Modes

Bi-directional traffic passage modes are: (1) controlled entry / controlled exit [Fig. 6], (2) controlled entry / free passage exit [Fig. 7]. Either of these configurations require users to wait for oncoming users to complete their passage before entering the turnstile.

**Fig. 6**    Controlled Entry / Controlled Exit

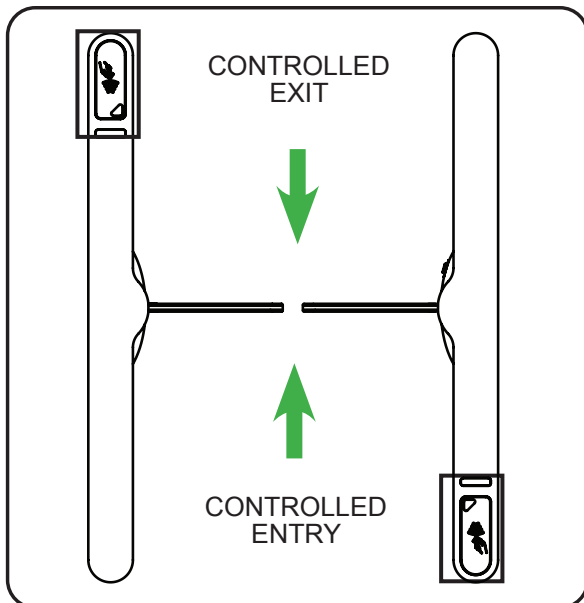

**Fig. 7**    Controlled Entry / Free-Passage Exit

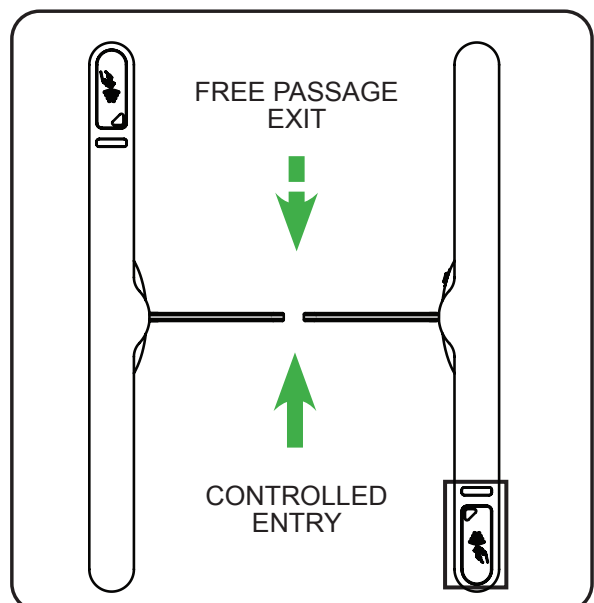





## Bi-directional Traffic and Smart Use of Passage Modes (cont.)

Bi-directional passage modes are generally suitable for low to medium volume applications. Traffic is generally heavy in only one direction at a time (arriving in the a.m. or leaving in the p.m.) and users naturally work out a protocol similar to drivers at a four-way stop.

For higher-level traffic applications, and where there are multiple turnstiles at an entry point, faster throughput can often be achieved by closing one direction of passage on select turnstiles as shown in [Fig. 8 & Fig. 9].

**Fig. 8** Morning / Return from Lunch

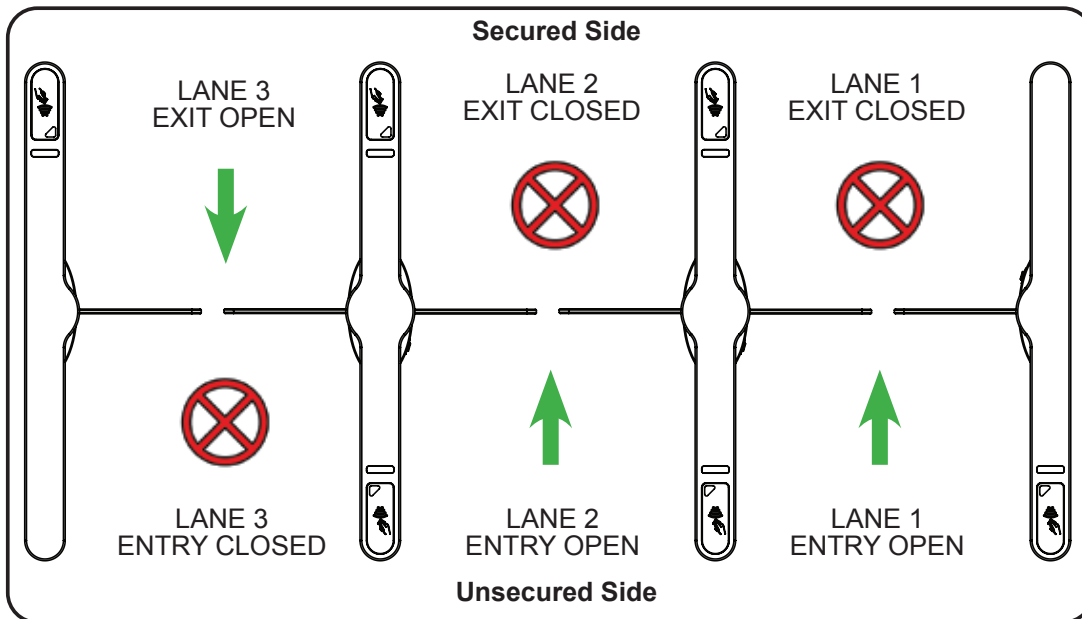

**Fig. 9** Evening / Leave to Lunch

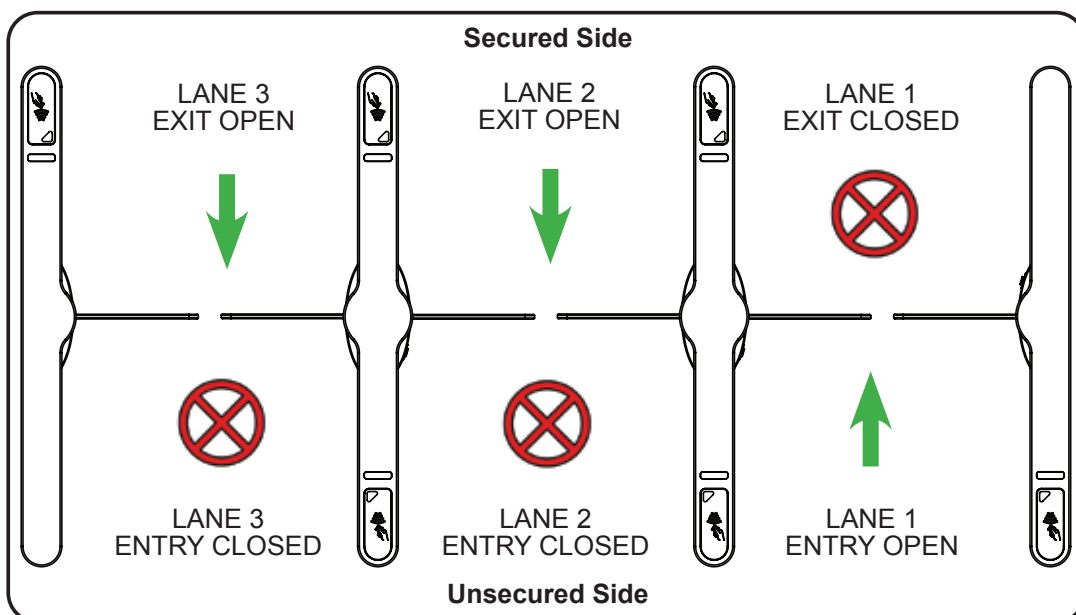







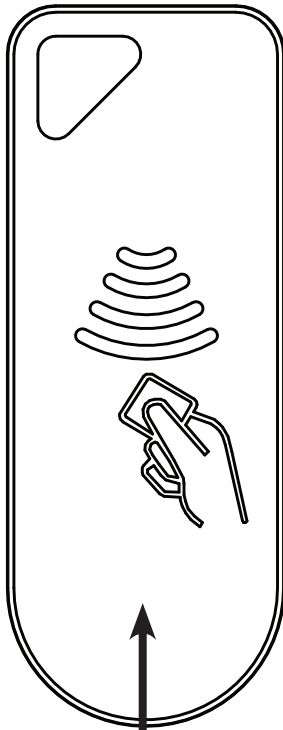

## User Status Display

The user status display is used to communicate turnstile and credential status to the user. There is one user status display located on the right-hand side of the turnstile lid for each direction of travel. The user status display functions as follows:

**Fig. 10** User Status Display



Card Presentation Area



User Status Icon	Indicates:
10A 	An illuminated yellow LED means the turnstile is ready for card presentation.
10B 	An illuminated green LED indicates passage is allowed after valid credentials have been presented.
10C 	An illuminated red LED indicates passage is prohibited.
10D  (Flashing)	A flashing green LED indicates the turnstile is in Free Passage mode.
10E  (Flashing)	A flashing red LED indicates the turnstile has an alarm condition and / or invalid credentials have been presented.



## Open / Close Status Light

Open / Closed Status Lights are mounted to the right-hand leg for each direction of entry. The lights function similar toll booth lights, and perform in the following manner:

**Fig. 11** Open / Closed Status Light

Status Light	Indicates:
11A 	An illuminated green bar indicates the turnstile is open for use. The bar remains green when a valid card input is received.
11B 	An illuminated red bar indicates the turnstile is closed for use. The barrier will not open in the direction of travel unless a fire alarm input is received.
11C  (Flashing)	A flashing red bar indicates the turnstile has an alarm condition.



## Operational Sounds

The SU5000 comes pre-configured with operational sounds to alert users and attendants of turnstile activity and alarm conditions. The sounds and alarms are played from the speakers mounted to each leg of Main and center cabinets.

The default operational sounds can be replaced with custom sounds using *LaneConfig*. Information on configuring operational sounds can be found in the *LaneConfig User Guide* located on the included File Management Utility USB drive.

**Table 1** Operational Sounds

Operational Sound / Alarm	Description	Alarm Sound File Name
Access Granted (Entry Direction)	Good card / access granted in the entry direction.	entgranted.wav
Access Denied (Entry Direction)	Bad card / access denied in the entry direction.	entdenied.wav
Access Granted (Exit Direction)	Good card / access granted in the exit direction.	extgranted.wav
Access Denied (Exit Direction)	Bad card / access denied in the exit direction.	extdenied.wav
Unauthorized Presence (Entry Direction)	User entered the turnstile in the entry direction without presenting card.	entunauth.wav
Unauthorized Presence (Exit Direction)	User entered the turnstile in the exit direction without presenting card.	extunauth.wav
Blocked Sensor (Entry Direction)	An operational sensor is blocked on the entry side of the turnstile.	entblk.wav
Blocked Sensor (Exit Direction)	An operational sensor is blocked on the exit side of the turnstile.	extblk.wav
Unsafe to Open (Entry Direction)	Barriers are not opening in the entry direction because an object is detected in the barrier swing path.	entunsafeopen.wav
Unsafe to Open (Exit Direction)	Barriers are not opening in the exit direction because an object is detected in the barrier swing path.	extunsafeopen.wav
Tailgating (Entry Direction)	Tailgating / unauthorized passage has been detected in the entry direction.	enttail.wav
Tailgating (Exit Direction)	Tailgating / unauthorized passage has been detected in the exit direction.	extail.wav

**Operational Sounds and Alarms (cont.)****Table 1** Operational Sounds (cont.)

<b>Operational Sound / Alarm</b>	<b>Description</b>	<b>Alarm Sound File Name</b>
Barrier Breakaway	Barriers have been forced open.	breakaway.wav
Barrier Impact	Barriers encountered an object when moving.	impact.wav
Barrier Held Open	Barriers remained open beyond the allotted time (default is 12 seconds).	panellingered.wav
Motor Fail	A motor failed to initialize during the start-up process.	motorfail.wav
Start-Up Complete	The turnstile start-up process is complete.	welcome.wav



## SU5000 Operation

### Powering On / Off

There is a power key switch on the inside of the base cover of all Main and center cabinets.

1. Power on the turnstile using the power key switch [Fig. 12]. The turnstile "boot up" cycle will take less than one minute to complete.
2. After the power-up sequence has completed, the SU5000 will enter the previously configured passage modes or the passage modes currently defined in GateKeeper.

As noted previously, passage mode settings are configured using the I/O control board inputs, GateKeeper software (if installed), or lane key control switch (if installed).

#### NOTE

SU5000s are factory set to operate in Controlled Passage mode in both the entry and exit directions.

**Fig. 12** Power Key Switch

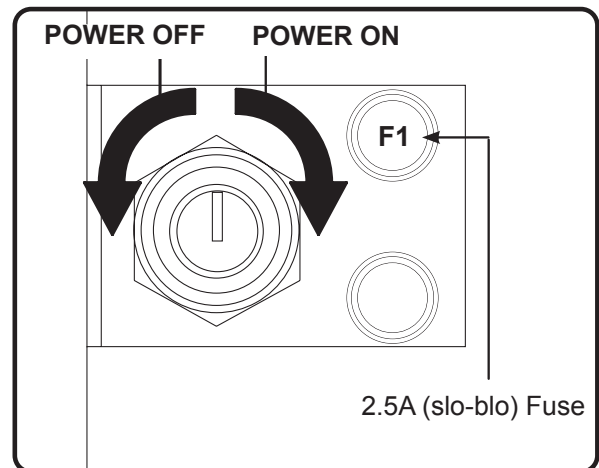



## Lane Key Control (Option)

Optional 3-position lane key control switches can be selected during the ordering process. Installed lane key control switches are used to change passage modes for both directions of travel. Two (2) lane key control switches are installed per turnstile in the bottom end legs as shown in [Fig. 13].

**Fig. 13** Lane Key Control Switch Locations

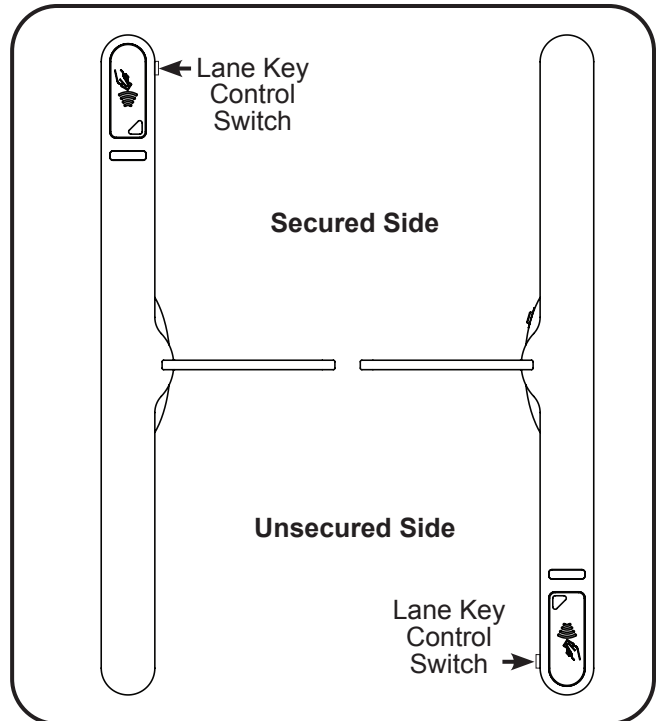

Turning the key to one of three positions overrides all existing settings, placing the turnstile in Controlled Passage mode, Free Passage mode or No Passage mode depending on the orientation of the key. Refer to the Passage Modes section on Page 15 for more information.

**Fig. 14** Lane Key Control Switch

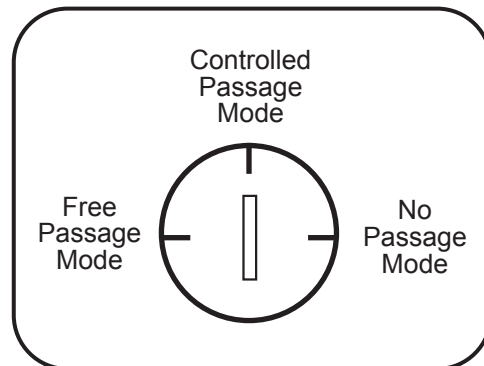

1. Turn the key to the position that corresponds to the desired passage mode as shown in [Fig. 14].



## User Instructions

### Operational & Safety Considerations

- Users may move briskly, but should not run due to safety considerations.
- Users should not stop and linger in the turnstile. Linger slows throughput and may trigger an alarm condition.
- Users with large bags, hand trucks, boxes, etc, should verify their combined width does not exceed passage width prior to entering the turnstile.
- Users requiring the use of a manual or motorized wheelchair should use designated wider passage turnstiles.

### Controlled Passage Mode

#### NOTE

It is assumed that card readers are installed under the top lid as shown in [Fig. 3] on page 10. Instructions on presenting credentials to other media devices are outside the scope of this User Guide.

Alvarado follows what we call the “right-hand rule.” Card readers are always installed on the right-hand side as the user enter the turnstile.

1. The open / closed status light is green, and the user status display's yellow LED is illuminated [Fig. 15].
2. Present the card to the turnstile by placing it in the center of the card read area shown in [Fig. 15]. Card read range varies from reader to reader. A best practice is to physically touch the card to the card read area. Avoid sliding the card on the card read area, as this does not improve readability.

#### TIP

The turnstile can be configured to emit an audible sound when an 'access granted' or 'access denied' signal is provided from the access control system. Most card readers have the capability to emit an audible sound upon card read. If both the turnstile and card reader audio is on, two sounds will be heard by the user. This can be confusing in certain applications. Consider disabling the card reader audio.

**Fig. 15** Controlled Passage Icon / Card Read Area

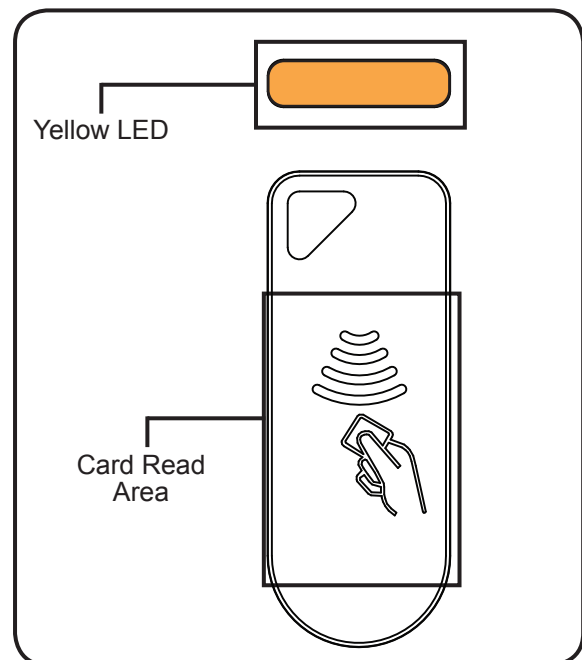





## User Instructions (cont.)

- Upon card validation:
  - Authorized Entry chime sounds.
  - Green LED illuminates on the user status display.
  - Barriers move to the open position.
- Promptly walk through the turnstile.

### TIPS

To improve throughput:

- Instruct users to have their credentials ready for presentation prior to arrival at the turnstile.
- Instruct users that they do not have to wait for the barriers to close before presenting credentials. The turnstile will stack activations and will process additional activations when barriers are opening, all the way open, or in the closing process. If the turnstile receives an activation signal when the barriers are open, the barriers stay open and allow the second user to pass. Similarly, if the turnstile receives an activation signal when the barriers are closing, the barriers will stop in mid-cycle and re-open for passage.
- Keep the turnstile entry and exit areas free of obstructions and dissuade users from talking or congregating in those areas.
- Consider designating turnstiles as entry or exit only, particularly during busy throughput times (see Page 17).

### Free Passage Mode

- The open / closed status light is green, and the user status display's green LED is blinking [Fig. 16].

### NOTE

If the dynamic side panel illumination option has been ordered, the user status display's green LED will be solid.

- Enter the turnstile. The free passage sensors will detect the user and the barriers will move to the open position.

**Fig. 16** Free Passage Icon

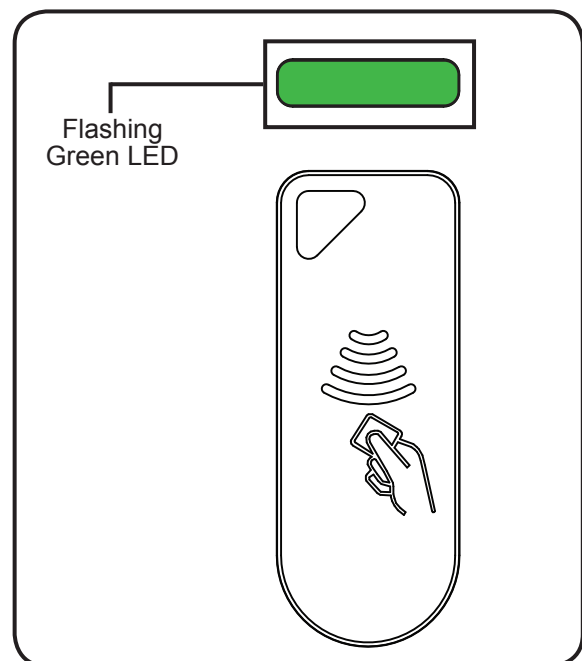



# Turnstile Operations

The following scenarios describe product behavior in common operational situations. Other operational information is available in other sections of this manual. Additional information can also be obtained by contacting Alvarado's technical support department.

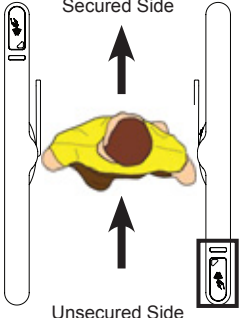
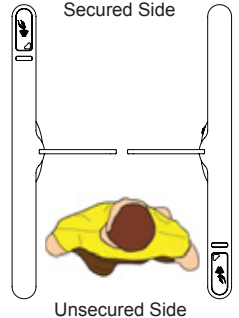
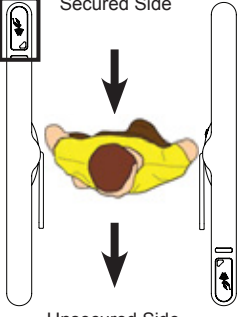
Function	Description	Turnstile Response	I/O Output
<p><b>Authorized Entry</b></p> 	<p>The user presents valid credentials to the card reader and completes an entry passage.</p>	<ul style="list-style-type: none"> <li>Authorized Entry chime sounds.</li> <li>Green LED illuminates on the entry side user status display.</li> <li>Barriers move to the entry open position, and close upon passage completion.</li> </ul>	YES
<p><b>Unauthorized Entry</b></p> 	<p>The user presents invalid credentials and/or enters the turnstile from the unsecured side without authorization.</p>	<ul style="list-style-type: none"> <li>Unauthorized Entry alarm sounds.</li> <li>Red LED flashes on the entry side user status display.</li> <li>Entry side open / closed light turns red.</li> <li>Barriers remain closed.</li> </ul>	YES
<p><b>Authorized Exit</b></p> 	<p>The user presents valid credentials to the card reader and completes an exit passage.</p>	<ul style="list-style-type: none"> <li>Authorized Entry chime sounds.</li> <li>Green LED illuminates on the exit side user status display.</li> <li>Barriers move to the entry open position, and close upon passage completion.</li> </ul>	YES

**Turnstile Operation (cont.)**

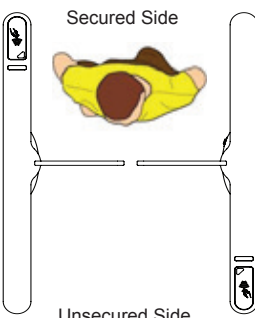
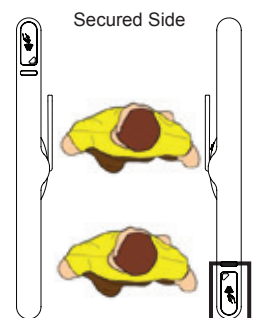
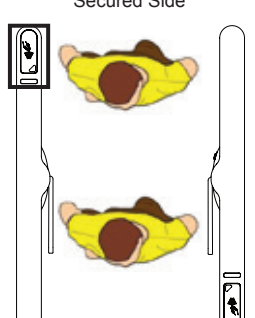
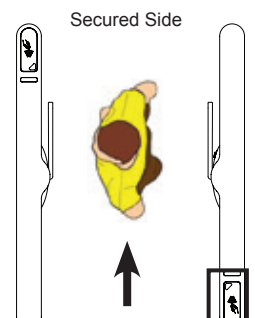
Function	Description	Turnstile Response	I/O Output
<p><b>Unauthorized Exit</b></p> 	<p>The user presents invalid credentials and/or enters the turnstile from the secured side without authorization.</p>	<ul style="list-style-type: none"> <li>Unauthorized Exit alarm sounds.</li> <li>Red LED flashes on the exit side user status display.</li> <li>Exit side open / closed light turns red.</li> <li>Barriers remain closed.</li> </ul>	<p>YES</p>
<p><b>Entry Stacking</b></p> 	<p>Users quickly and consecutively present credentials to the turnstile (up to one card per second). The turnstile "stacks" the activations and processes users as fast as they can walk through the turnstile.</p>	<ul style="list-style-type: none"> <li>Authorized Entry chime sounds for each activation.</li> <li>Green LED illuminates on the entry side user status display.</li> <li>Barriers move to the entry open position, and close after the last user has completed passage.</li> </ul>	<p>NO (Individual Authorized Entry Passage outputs are logged.)</p>
<p><b>Exit Stacking</b></p> 	<p>Users quickly and consecutively present credentials to the turnstile (one card per second). The turnstile "stacks" the activations and processes users as fast as they can walk through the turnstile.</p>	<ul style="list-style-type: none"> <li>Authorized Entry chime sounds for each activation.</li> <li>Green LED illuminates on the exit side user status display.</li> <li>Barriers move to the open position, and close after the last user has completed passage.</li> </ul>	<p>NO (Individual Authorized Exit Passage outputs are logged.)</p>
<p><b>Barrier Held Open (Entry Direction)</b></p> 	<p>While performing an authorized entry passage, the user stops and lingers, preventing the barriers from closing.</p>	<p>After remaining in the turnstile for 12 seconds:</p> <ul style="list-style-type: none"> <li>Barrier Held Open alarm sounds.</li> <li>Red LED flashes on both user status displays.</li> <li>Both open / closed lights flash red.</li> <li>The alarm condition continues until the user exits the turnstile.</li> </ul>	<p>YES</p>

**Turnstile Operation (cont.)**

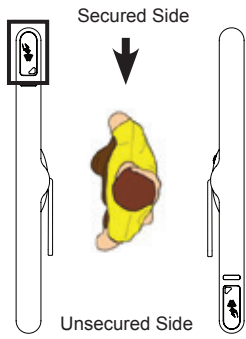
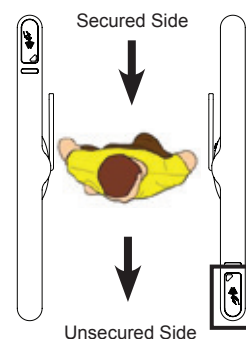
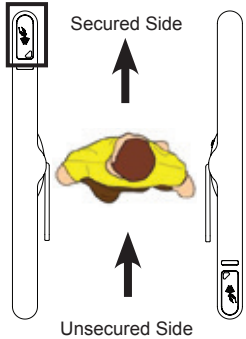
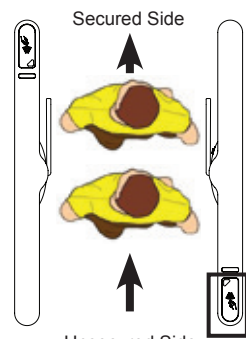
Function	Description	Turnstile Response	I/O Output
<p><b>Barrier Held Open (Exit Direction)</b></p> 	<p>While performing an authorized exit passage, the user stops and lingers, preventing the barriers from closing.</p>	<p>After remaining in the turnstile for 12 seconds:</p> <ul style="list-style-type: none"> <li>The Barrier Held Open alarm sounds.</li> <li>Red LED flashes on both user status displays.</li> <li>Both open / closed lights flash red.</li> <li>The alarm condition continues until the user exits the turnstile.</li> </ul>	YES
<p><b>Unauthorized Exit Passage</b></p> 	<p>User activates the turnstile from the unsecured side.</p> <p>When the barriers move to the open position, a unauthorized user performs an exit passage from the secured side.</p>	<p>When the unauthorized user enters the turnstile from the secured side:</p> <ul style="list-style-type: none"> <li>The Unauthorized Exit passage alarm sounds for 4 seconds.</li> <li>Red LED flashes on the exit side user status display.</li> <li>Exit side open / closed light flash red.</li> </ul>	YES
<p><b>Unauthorized Entry Passage</b></p> 	<p>User activates the turnstile from the secured side.</p> <p>When the barriers move to the open position, an unauthorized user performs an entry passage from the unsecured side.</p>	<p>When the unauthorized user enters the turnstile from the unsecured side:</p> <ul style="list-style-type: none"> <li>The Unauthorized Entry Passage alarm sounds.</li> <li>Red LED flashes on the entry side user status display.</li> <li>Entry side open / closed light turns red.</li> </ul>	YES
<p><b>Tailgate Entry</b></p> 	<p>An unauthorized user closely follows an authorized user to enter the facility.</p>	<p>When the unauthorized user tailgates:</p> <ul style="list-style-type: none"> <li>The Unauthorized Presence alarm sounds.</li> <li>Red LED flashes on the user status display.</li> <li>Open / closed light turns red.</li> <li>The Unauthorized Entry Passage alarm sounds for 4 seconds.</li> </ul>	YES

**Turnstile Operation (cont.)**

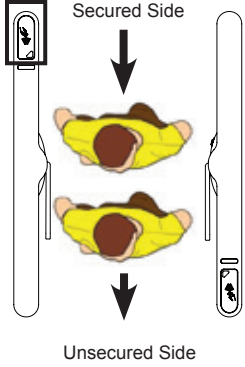
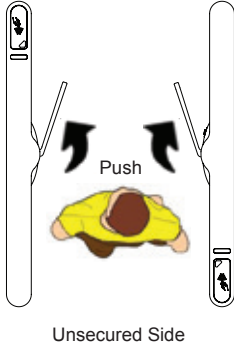
Function	Description	Turnstile Response	I/O Output
<p><b>Tailgate Exit</b></p> 	<p>An unauthorized user closely follows an authorized user to exit the facility.</p>	<p>When the unauthorized user tailgates:</p> <ul style="list-style-type: none"> <li>• The Unauthorized Presence alarm sounds.</li> <li>• Red stop icon flashes on the exit side user status display.</li> <li>• Exit side open / closed status light flashes red.</li> <li>• The Unauthorized Exit Passage alarm sounds for 4 seconds.</li> </ul>	<p>YES</p>
<p><b>Barrier Breakaway</b></p> 	<p>User pushes on the barriers until they break away.</p>	<p>After the barriers break away:</p> <ul style="list-style-type: none"> <li>• Unauthorized Entry alarm sounds.</li> <li>• Red LED flashes on the both user status displays.</li> <li>• Both open / closed lights flash red.</li> <li>• Two seconds after the user steps out of the turnstile, the turnstile returns to previous passage mode.</li> </ul>	<p>YES</p>

**Turnstile Operation (cont.)**

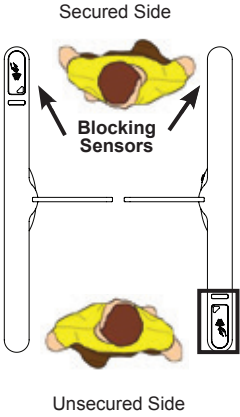
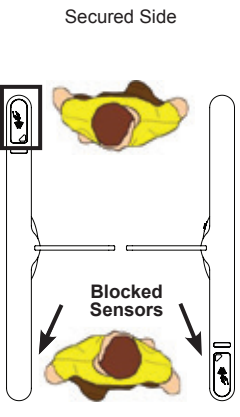
Function	Description	Turnstile Response	I/O Output
<p><b>Unsafe to Open Entry</b></p>  <p>Secured Side</p> <p>Blocking Sensors</p> <p>Unsecured Side</p>	<p>Barriers do not open after the turnstile is activated from the entry side, due to an object or user detected in the exit side of the turnstile.</p>	<p>After the entry activation:</p> <ul style="list-style-type: none"> <li>• The turnstile detects the obstruction and the Unsafe to Open alarm sounds.</li> <li>• Red LED flashes on the entry side user status display.</li> <li>• Entry side open / closed light flashes red.</li> </ul>	NO
<p><b>Unsafe to Open Exit</b></p>  <p>Secured Side</p> <p>Blocked Sensors</p> <p>Unsecured Side</p>	<p>Barriers do not open after the turnstile is activated from the exit side, due to an object or user detected in the entry side of the turnstile.</p>	<p>After the entry activation:</p> <ul style="list-style-type: none"> <li>• The turnstile detects the obstruction and the Unsafe to Open alarm sounds.</li> <li>• Red LED flashes on the entry side user status display.</li> <li>• Entry side open / closed light flashes red.</li> </ul>	NO

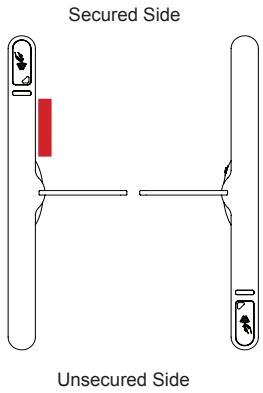
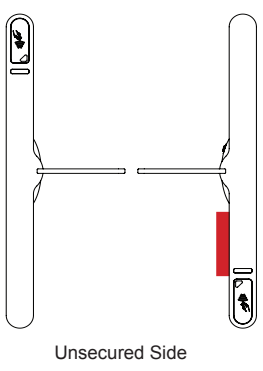

# Turnstile Operation (cont.)

Function	Procedure	Turnstile Response	I/O Output
<p><b>Blocked Sensor (Entry Direction)</b></p> 	<p>Object is blocking the entry side operational sensors for 15 seconds or longer.</p>	<ul style="list-style-type: none"> <li>• Entry Blocked Sensor alarm sounds.</li> <li>• Red LED flashes on the both user status display.</li> <li>• Both open / closed lights flash red.</li> </ul>	<p>YES</p>
<p><b>Blocked Sensor (Exit Direction)</b></p> 	<p>Object is blocking the exit side operational sensors for 15 seconds or longer.</p>	<ul style="list-style-type: none"> <li>• Entry Blocked Sensor alarm sounds.</li> <li>• Red LED flashes on the entry side user status display.</li> <li>• Both open / closed lights flash red.</li> </ul>	<p>YES</p>



## I/O Control

This section explains the various I/O control board inputs and outputs, and how they may be used. It is assumed that the turnstiles are already installed and interfaced with the access control system. For access control wiring instructions, please refer to the *SU5000 Installation Instructions*.

### Inputs

The following inputs are available for access control system signals:

**Fig. 17** Input Terminal Block

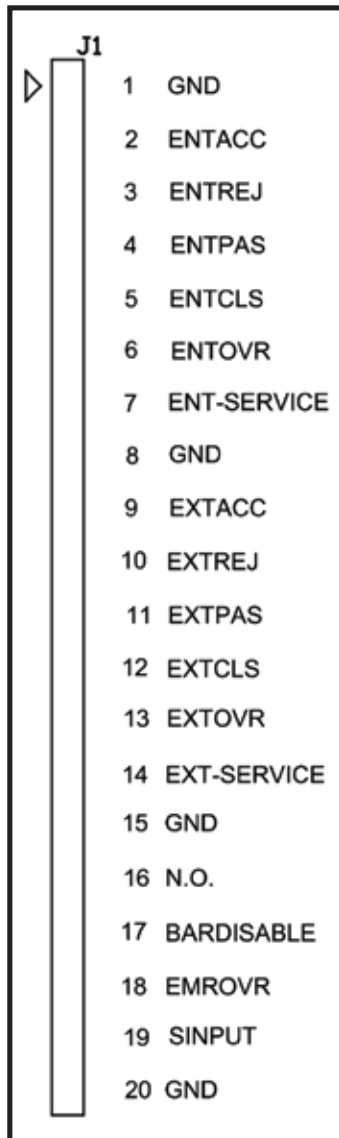

#### PINS 1, 8, 15, 20 - GND (Common Ground)

##### Description

Common ground terminals for access control system wiring. Only for input terminal block use.

##### Purpose and Customer Use

Access control system outputs that require a ground return are connected to these inputs.

#### PIN 2 - ENTACC / PIN 9 - EXTACC (Card Accept)

##### Description

Receipt of an input contact opens the barriers for a single passage in the appropriate direction.

##### Purpose and Customer Use

These are core system inputs. ENTACC (entry accept) signals the turnstile to allow a single valid passage in the entry direction. EXTACC (exit accept) signals the turnstile to allow a single valid passage in the exit direction. Typically these signals are provided after the access system determines that the card presented at the turnstile is valid for entry. ENTACC is used on virtually every installation. EXTACC is used in controlled entry / exit applications where users both card in and card out.





## Inputs (cont.)

### PIN 3 - ENTREJ / PIN 10 - EXTREJ (Card Reject)

#### **Description**

Receipt of an input contact instructs the turnstile that the presented credential is invalid.

#### **Purpose and Customer Use**

These inputs notify users that presented credentials are not authorized. ENTREJ signals the turnstile to notify the user that the credential presented in the entry direction is not authorized.

### PIN 4 - ENTPAS / PIN 11 - EXTPAS (Free Passage Mode)

#### **Description**

Receipt of an input contact places the turnstile in Free Passage mode in the appropriate direction.

#### **Purpose and Customer Use**

These inputs can be used if the customer desires to change passage modes through the use of remote key switches or buttons, and has not purchased the turnstile key control or GateKeeper options.

### PIN 5 - ENTCLS / PIN 12 - EXTCLS (No Passage Mode)

#### **Description**

Receipt of an input contact places the turnstile in No Passage mode in the appropriate direction.

#### **Purpose and Customer Use**

These inputs are typically used by the customer only if the customer desires to change passage modes through the use of key switches or buttons and has not purchased the lane key control or GateKeeper options.



# Inputs (cont.)

## PIN 6 - ENTOVR / PIN 13 - EXTOVR (Override)

### Description

Receipt of an input contact allows a single authorized passage in the appropriate direction.

### Purpose and Customer Use

These inputs are similar in operation to ENTACC / EXTACC and are typically used to allow an attendant to authorize entry or exit from an attendant desk using a key switch or button.

## PIN 18 - EMROVR (Emergency Override)

### Description

Receipt of an input contact (or removal of a contact) places the turnstile in Emergency Override mode.

### Purpose and Customer Use

This is a core system input. Typically, the building fire system is wired into this contact point. This input is configured as either normally open (N.O.) or normally closed (N.C.) using the JP3 jumper located on the I/O control board [Fig. 18]. Configure the JP3 jumper as required by the fire alarm safety system. The factory default setting is normally open (N.O.).

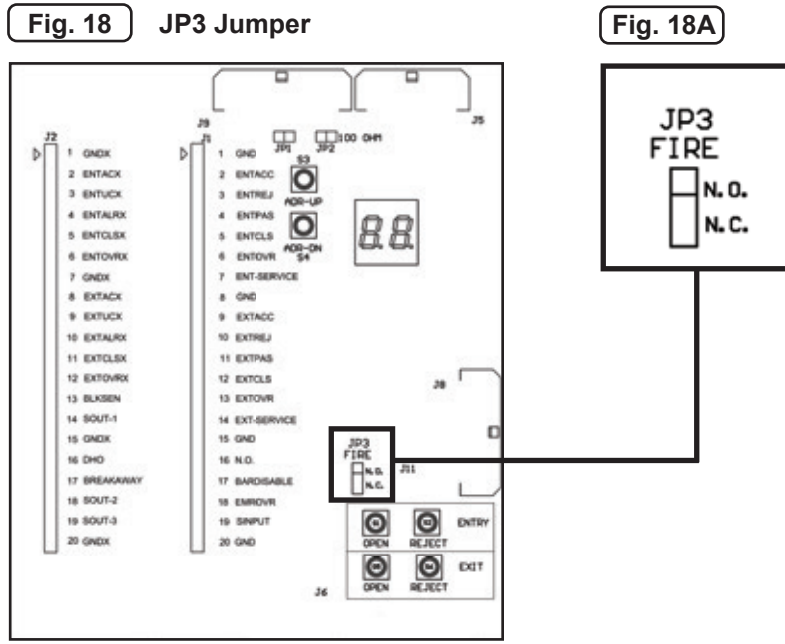

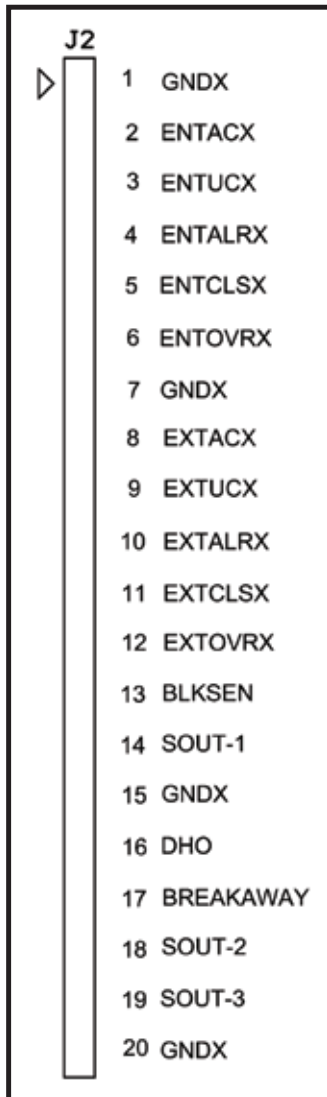

# Outputs

**Fig. 19****Output Terminal Block**

The following outputs are available to provide information on turnstile operational status and activity. All output contacts are 500ms in duration.

### PINS 1, 7, 15, 20 - GNDX (Common Ground)

#### **Description**

Common ground terminals for access control system wiring. Only for output terminal block use.

#### **Purpose and Customer Use**

Access control system inputs that require a ground return are connected to these outputs.

### PIN 2 - ENTACX / PIN 8 - EXTACX (Authorized Passage)

#### **Description**

An output contact is generated when a user completes an authorized passage in the appropriate direction. This signal is generated when a passage occurs after receipt of an ENTACC / EXTACC signal, after receipt of an ENTOVR / EXTOVR signal, or after a passage if the turnstile direction is in Free Passage Mode.

#### **Purpose and Customer Use**

These outputs can be used by the facility access control system to track the number of authorized passages through the turnstile, or compare authorized entry or exit signals issued by the facility access control system against passages.



## Outputs (cont.)

### PIN 3 - ENTUCX / PIN 9 - EXTUCX (Unauthorized Passage)

#### **Description**

An output contact is generated when a user completes an unauthorized passage (i.e., tailgating after an authorized passage) in the appropriate direction. This is typically referred to by Alvarado as an “unauthorized passage” output.

#### **Purpose and Customer Use**

These are important outputs to monitor as they identify unauthorized passages. The outputs are typically used to identify the time and location of unauthorized passages. This allows review of the unauthorized passage on security camera footage (if available).

### PIN 4 - ENTALRX / PIN 10 - EXALRX (Unauthorized Entry/Exit)

#### **Description**

An output contact is generated when a user enters the turnstile without the turnstile receiving an authorized passage signal (ENTACC / EXTACC or ENTOVR / EXTOVR).

#### **Purpose and Customer Use**

This output is generated when a user gets close to the barrier before the turnstile receives an authorized entry or exit signal. This can be caused by users entering the turnstile too far before presenting their credentials, or by users presenting their credentials and entering the passage area before the access system sends an authorization signal to the turnstile.

Customers typically do not monitor unauthorized entry/exit outputs, but they can be useful to monitor for a short time after installation. A large number of unauthorized entry/exit outputs can indicate that further user training is required, or that there may be adjustments required with respect to the card reader or the access system response time.

### PIN 13 - BLKSEN (Blocked Sensor)

#### **Description**

An output contact is generated when any of the turnstile's transmit / receive sensors in the operational sensor arrays cannot communicate for a defined time period (factory default is 15 seconds). This output is generated without regard to the state of the panels (open or closed).

#### **Purpose and Customer Use**

This output is an important output to monitor. It would provide notification of a person or object lingering in the turnstile passage area or, as an example, if an object (such as a piece of gum or putty) was inhibiting communication between the sensors. Security camera footage (if available) can be used to review the situation surrounding generation of this output if desired.



## Outputs (cont.)

### PIN 16 - DHO (Barrier Held Open)

#### **Description**

Barrier Held Open is both a setting and an output.

As a setting (accomplished through LaneConfig), the DHO timeout defines the time after which barriers will close if a number of card accept (ENTACC or EXTACC) or override (ENTOVR or EXTOVR) signals are received, but users do not pass through the lane. As an example, after a card accept or override signal, the barriers remain open until a user passes, or for the defined open period if a user does not pass. If a number of card accept or override signals are received in succession (and there is no user passage), the DHO setting limits the time the barriers remain open after the last card accept or override signal to the defined DHO time period (default is 12 seconds).

An output is generated when barriers remain open past the defined DHO time. One example of when this might occur would be if a sensor in the closing path of the barriers were blocked after opening. In this case, for safety reasons the barriers will remain open. In such a case the turnstile will generate a DHO output. This would be in addition to the local alarm that would sound at the turnstile.

#### **Purpose and Customer Use**

The DHO output is an important output to monitor. It provides notification if barriers remain open beyond the expected "open" time. Security camera footage (if available) can be used to review the situation surrounding generation of this output if desired.

### BREAKAWAY (Barrier Broken Away) (Pin 17)

#### **Description**

An output contact is generated when the barrier holding force threshold has been exceeded and the barrier gives way. If the user proceeds through the turnstile, an unauthorized passage output will also be generated.

#### **Purpose and Customer Use**

This is an important output that is monitored by most customers. Security camera footage (if available) can be used to review the situation surrounding a breakaway alarm.



## SU5000 Configuration Preparation

### Overview

SU5000 configuration changes are broken down into two sections: configuring the turnstile operating system, and configuring the turnstile application. Each type of configuration requires a different configuration tool.

Configuring the turnstile operating system is accomplished using the *UltraVNC Viewer* application (included on the File Management Utility USB provided with the turnstile). Configurable operating system settings include the system time, IP address, and speaker volume. Typically, operating system settings are configured before turnstile application settings.

Configuring the turnstile application is accomplished using the *LaneConfig* (also included on the File Management Utility USB). Configurable turnstile application settings include alarm sounds, detection settings, and alarm timer settings. Instructions on using LaneConfig can be found in the *LaneConfig User Guide* located on the File Management Utility USB.

There are two ways to connect to the turnstile: 1) via a computer on the facility network (if networked), or 2) via a local laptop computer connected directly to the turnstile (if not networked). Keep in mind that newly installed turnstiles that will be networked must first be configured using a local laptop computer to set the network IP address.

This User Guide assumes you are configuring newly installed turnstiles via a local laptop computer. If your turnstiles are already networked and configured with a network IP address, refer to the *LaneConfig* documentation for installation and configuration instructions.

### New Installation Configuration Checklist

Perform the following configuration steps for newly installed turnstiles.

#### Install Configuration Tools

1. UltraVNC
2. LaneConfig

#### Connect Laptop Computer to the Turnstile

1. Remove base cover to access Ethernet adapter.
2. Connect laptop computer to the Ethernet extension cable using an Ethernet cable.

#### Configure Operating System Settings Using UltraVNC Viewer

1. Set local system time.
2. Set turnstile IP address (required for networked turnstiles).

#### Configure Turnstile Software Settings Using LaneConfig (optional)

1. Configure turnstile parameters.

#### NOTE

The factory default settings are appropriate for most installations. If the facility requires a particular turnstile setting to be changed, change it at this time.



## Installing the Configuration Tools

Both *UltraVNC Viewer* and the *LaneConfig* installation package are located on the File Management Utility USB that was provided with the turnstile. If you are unable to locate, or have misplaced, the File Management Utility USB, contact Alvarado Technical Support.

### Computer Requirements

- Operating System - Windows 7 / Windows 8 / Windows 10
- .NET Framework 4.0 or greater
- Available USB Port

### Installing UltraVNC Viewer

1. Insert the File Management Utility USB into the computer.
2. Navigate to X:\File Management Utility USB\UltraVNC Software.
3. Double-click the **UltraVNC\_x.x.x.x\_Setup** icon to begin the installation.
4. During the installation process, go with the default selections with the exception of the **Select Components** screen, in which **UltraVNC Viewer Only** should be selected.
5. Follow the installation prompts until the installation is complete.

### Installing LaneConfig

Refer to the *LaneConfig Installation Guide* for installation instructions additional computer requirements.



## Connecting a Laptop Directly to the Turnstile

The SU5000 turnstile communicates with a computer or facility network via the main turnstile controller's Ethernet adapter. An Ethernet extension cable is tucked inside the base cover on all Main and center cabinets. To access the Ethernet extension cable, the base cover will need to be removed. Instructions on removing the base cover can be found in the *SU5000 Installation Instructions*.

1. Locate the Ethernet extension cable tucked in the base of the Main / center cabinet [Fig. 20].
2. Connect the Ethernet cable from the computer to the Ethernet extension cable.

### NOTE

If network cable was run to the turnstile via conduit, temporarily disconnect the network cable from the Ethernet extension cable to configure the turnstile. Once the turnstile has been configured, reconnect the network cable.

**Fig. 20** Ethernet Adapter

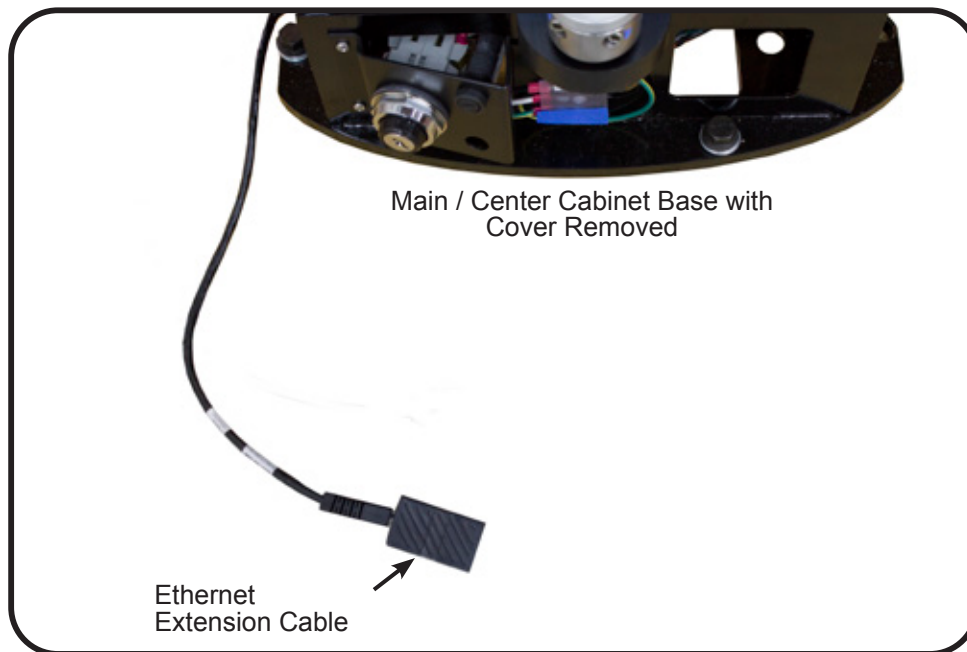





## Operating System Configuration

Operating system settings are configured using the **UltraVNC Viewer** application.

- It is assumed that the turnstile is powered ON and connected to the computer or facility network.

1. Launch UltraVNC Viewer.
2. Enter the turnstile IP address in the **VNC Server** field [Fig. 21]:
  - If this is a newly installed or non-networked turnstile, enter the factory default turnstile IP address: **192.168.0.100**.
  - If the turnstile has already been configured with a facility network IP address, enter that network IP address.
3. Click the **Connect** button.

**Fig. 21** UltraVNC Viewer

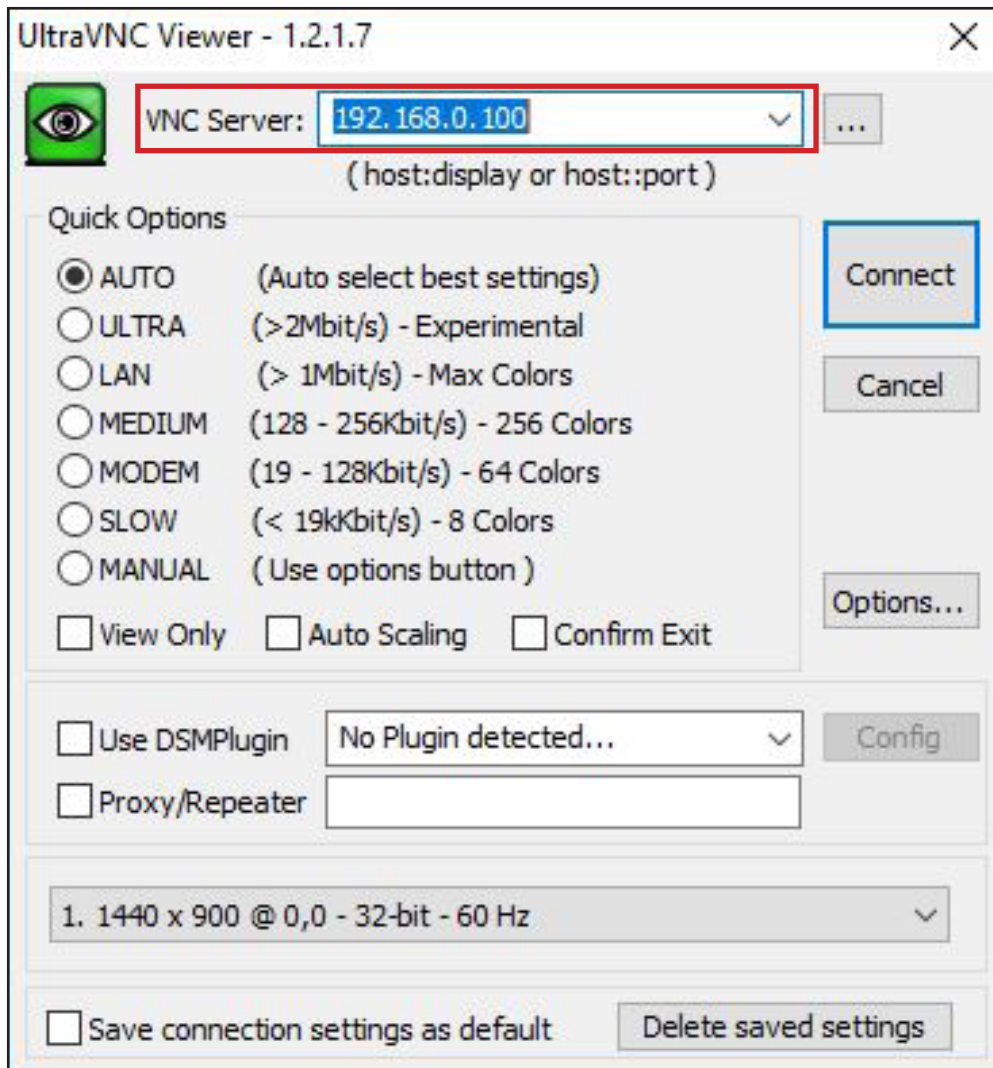



## Operating System Configuration (cont.)

4. Enter: **alvarado** for the password at the VNC Authentication window [Fig. 22].
5. Click the **Log On** button.

**Fig. 22** UltraVNC Viewer



6. Upon password verification, the SU5000 desktop will appear onscreen [Fig. 23]. Communication with the turnstile is now established.

**Fig. 23** SU5000 Desktop





## Setting the Local System Time

The operating system time is factory set to Pacific Time (U.S. and Canada). The operating system time should be set for your local time. To set the time, follow the instructions below.

1. Double-click the time display in the bottom right corner of the SU5000 desktop to bring up the 'Date / Time Properties' window [Fig. 24].

**Fig. 24** Time Display



2. Enter the correct **Date**, **Current Time**, and **Time Zone** in the appropriate fields [Fig. 25].
3. Press **OK** to save the time setting.

**Fig. 25** Date/Time Properties Window

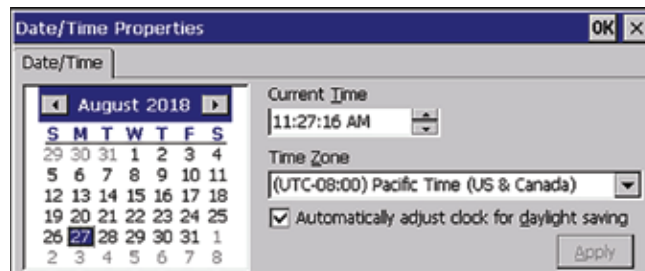



## Setting the Local System Time

4. Click **Start**, click **Programs**, and click **SaveReg** [Fig. 26].

**Fig. 26** Saving the Registry





## Setting the Turnstile IP Address

The turnstile IP address only needs to be configured on networked turnstiles.

1. Open a web browser on your computer.
2. Type the SU5000's **IP address** into the address bar and press **Enter**. The default IP address is 192.168.0.100.
3. Enter **admin** into the *User Name* field and **alvarado** into the *Password* field. Click **Log In** [Fig. 27].

**Fig. 27** Remote Admin - Authentication Required

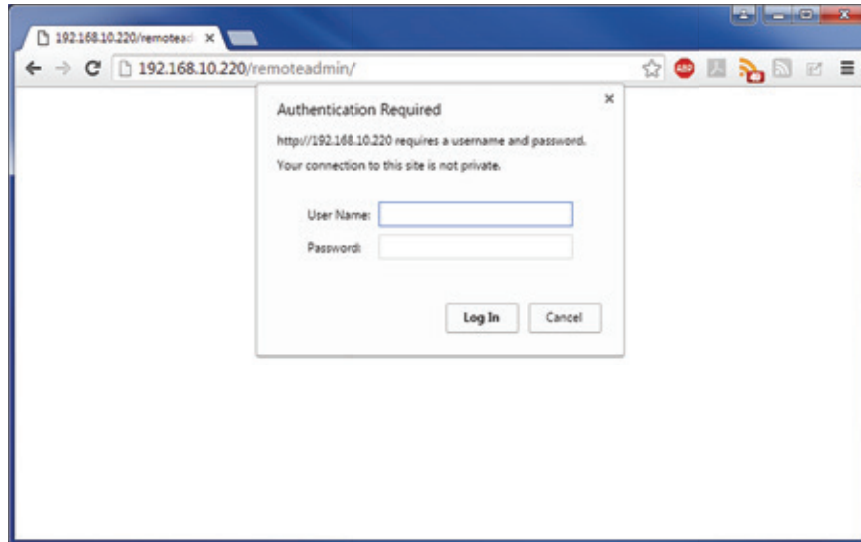

4. Click the arrow for **Device Management** to expand the list and select **Configure Network** [Fig. 28].

**Fig. 28** Remote Admin - Device Management Menu

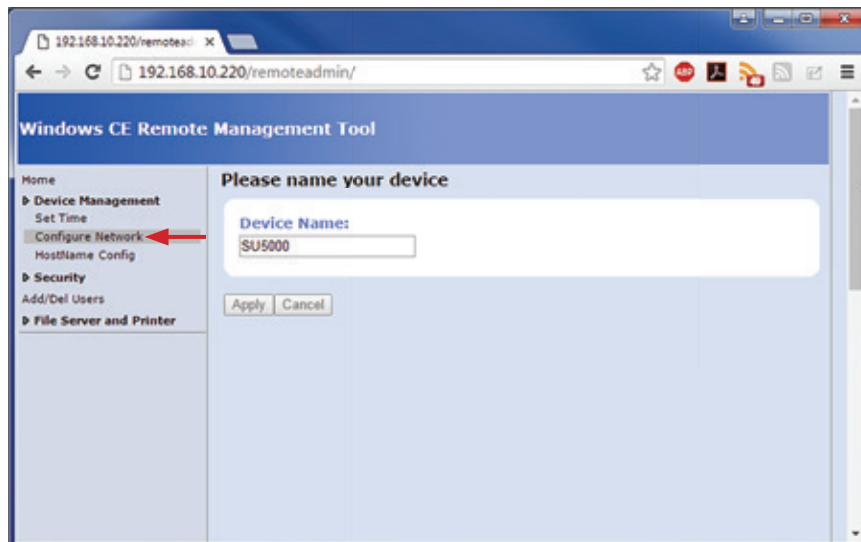



## Setting the Turnstile IP Address (cont.)

5. Enter the correct network information into the appropriate fields. Click **Submit** when finished [Fig. 29].

**Fig. 29** Remote Admin - Network Configuration

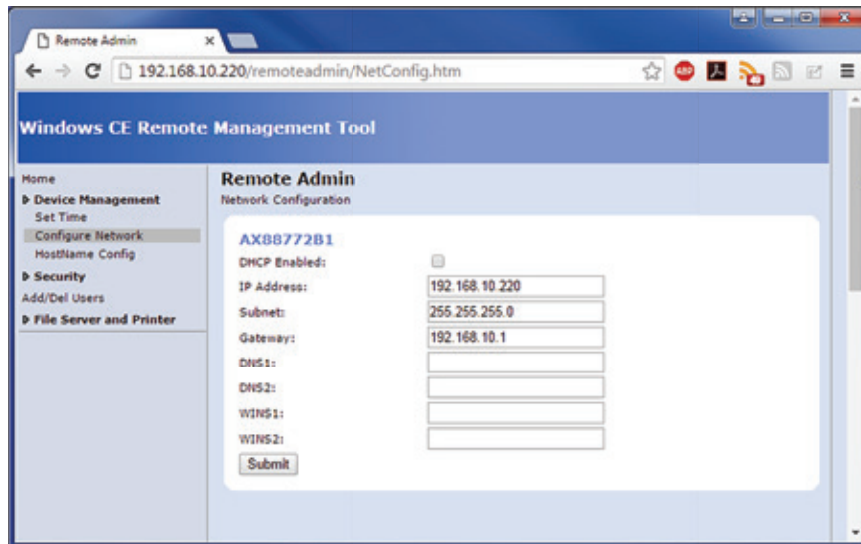

6. Wait for the Gateway to finish resetting. If the new IP address is on the same subnet as it was before, you will go back to the *Network Configuration* page. Otherwise, you will lose connection to the *Remote Admin* tool. Either outcome indicates the network configuration changed successfully.

**Fig. 30** Remote Admin - Gateway Resetting

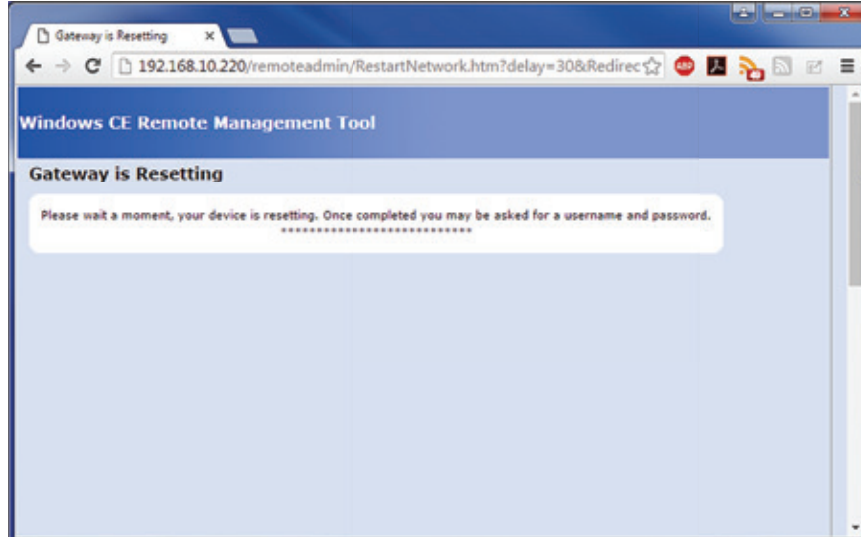



## Maintenance

Preventative maintenance should be performed periodically after installation to ensure the product maintains its visual exterior and optimal performance. To maintain the SU5000, follow the instructions below as needed. Due to the various types of exterior finishes on the SU5000, different types of care must be taken to keep the unit clean and undamaged.

### Cleaning the Cabinet Exterior

Regular cleaning is the best way to maintain any stainless steel or finished equipment and prevent corrosion.

1. Stainless steel surfaces may be cleaned using any commercially available stainless steel cleaner or polish. If a heavier scratch mark is apparent, a metal blend and finish pad by 3M Company or equivalent may be used followed by a stainless steel cleaner. **ALWAYS POLISH IN THE DIRECTION OF THE GRAIN.**
2. Color powder coat finished cabinet surfaces may be cleaned using a soft damp cloth. Any deep scratched in this type of finish should be touched up to prevent rust or corrosion from forming. If left untreated, rust can spread under the powder coat finish.

### Cleaning Moving Barriers, Side Panels and Sensor Lens Covers

Use cleaning products that are specifically recommended for use on acrylic surfaces. We recommend two products:

- ***Brillianize***
- ***Novus #1***

The two recommended products will clean the material and leave a greaseless shine that will repel dust and resist fingerprints. **DO NOT** use scouring compounds or chemical cleaners like Windex that contain ammonia or alcohol.

1. Using a soft cloth, clean the acrylic surfaces according to the instructions provided with the recommended cleaning product. **DO NOT SCRUB THE ACRYLIC!**
2. Check for cracks or scratches on the acrylic sensor lens covers. Sensor lens covers should only be replaced if they are inhibiting the function of the unit.





## Maintenance (cont.)

### Interior Maintenance

Internal maintenance should occur once every year. Refer to the *SU5000 Installation Instructions* for details on how to access the interior of the turnstile. Dust build up is the most important concern inside the cabinet. Use canned air dust remover to clean out all the dust from the inside of the cabinet and specific areas noted below.

1. **Printed Circuit Boards (PCBs):** Using canned air dust remover, blow out the dust on the printed control boards.
2. **Sensors:** Using canned air dust remover, clean the dust from the optical sensors.

## Weekly Safety Check

Perform the following safety check on a weekly basis to ensure that the turnstile is safe and ready for user operation. If the turnstile does not pass the Activation or Unsafe to Open tests, do not use the turnstile. Contact your service professional or Alvarado for assistance.

1. **Barrier Alignment** - Ensure that the barriers are properly aligned in the Home Position. If necessary re-home the barrier(s). Refer to the *SU5000 Installation Instructions* for instructions on setting the Home Position.
2. **Attachment** - Verify that the barriers, top channel lids, and cabinet panels are secure. If necessary, tighten screws.
3. **Passageway** - Check the turnstile passageway and entry and exit areas for trash or other debris that may impede traffic or be a safety hazard.
4. **Test Activation** - Activate the turnstile and complete a passage in both the entry and exit directions.
5. **Unsafe to Open Entry / Unsafe to Open Exit** - Perform an Unsafe to Open test in both the entry and exit directions. Verify the turnstile responds with the Unsafe to Open alarm condition. Refer to the Turnstile Operation section on Page 30 for more information on Unsafe to Open operation.





## Troubleshooting

Use this troubleshooting section to diagnose and resolve common turnstile issues. If your particular issue is not covered in this troubleshooting section, please contact Alvarado Technical Support for further troubleshooting assistance.

Symptom	Possible Cause	Solution
Unit will not turn on	No power	Make sure that there is power to the turnstile power terminal block. Check if LEDs are lit on the I/O control board and the seven-segment display is showing a number.
	Blown fuse	Check fuse. If necessary replace with a 2.5A (slo-blo) fuse.
Constant auditory alarming	Communication/ low-voltage cable	Check the I/O control board to see if amber LEDs are lit. If they are lit, the most likely problem is a loose or improper communication connection. Disconnect the black 16-pin connectors from the I/O control board and motor controller boards, apply contact cleaner / lubricant to connector pins and reseal. Retry operation.  If condition persists, perform the same process on the 16-pin connectors going into and out of the light boards and sensor boards. Retry operation. Alvarado Technical Support has a process document and can provide additional instructions.
Barriers operate erratically	Digital position encoder is not in place	Verify the digital position encoder is secured to the pulley shaft with all the locks tabs in place. [Fig. 31]. <b>NOTE: After re-seating the digital position encoder, the barrier home position must be reset PRIOR to power cycling the turnstile.</b>
Barriers do not move.	Blown 24VDC fuse on the motor controller board.	Locate the motor controller board fuses [Fig. 32]. Using a multimeter, check the 24VDC 6.3A fuse for continuity. If the fuse is blown, contact Alvarado for replacement instructions.
Blocked Sensor Auditory Alarms sounds after 15 seconds (default).	Wire or cable blocking sensors	Check for a stray wire or cable in front of the transmit and receive operational sensors (horizontal arrays). Tuck any stray wire or cable out of sensor viewing area. If this does not resolve the problem, contact Alvarado Technical Support for instructions on using the ADR-UP and ADR-DN buttons on the I/O control board to perform diagnostics on sensors.
Barriers either stay open or start to close then open back up	Safety sensor blocked	Check for a stray wire or cable in front of the individual transmit and receive safety sensors. Tuck any stray wire or cable out of sensor viewing area. If this does not resolve the problem, contact Alvarado Technical Support for instructions on using the ADR-UP and ADR-DN buttons on the I/O control board to perform diagnostics on sensors.
Barriers do not align in closed position	Home Position needs to be reset	Follow the Setting the home position instructions located in Appendix A of the <i>SU5000 Installation Instructions (PUD3667)</i> .

## Troubleshooting (cont.)

**Fig. 31** Digital Position Encoder

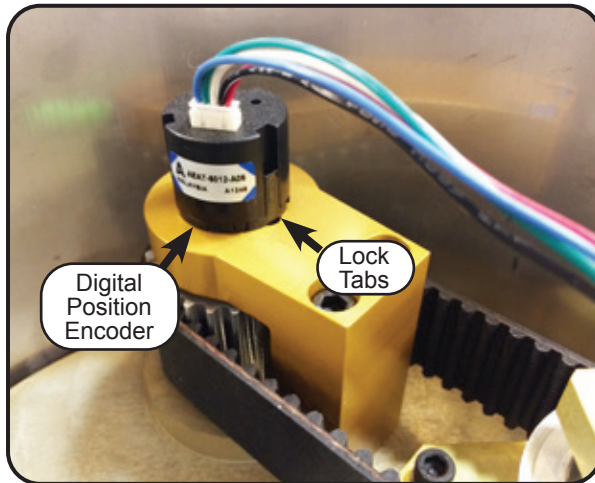

**Fig. 32** Motor Controller Board Fuses

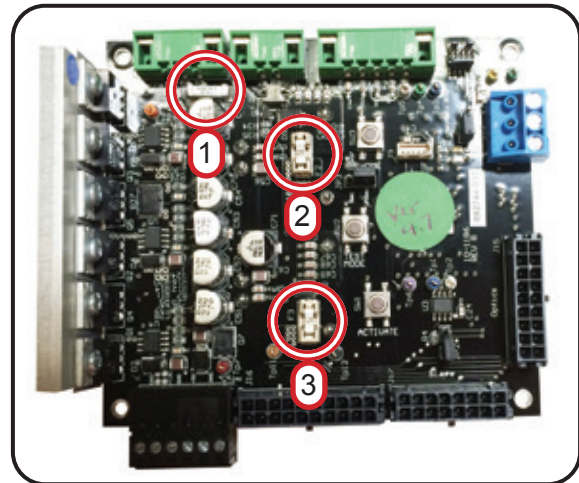

### FUSES

- 1) 24VDC 6.3A    2) 12VDC 2A    3) 5VDC 3A

**Revision History**

Revision	Date	Author	Description
1-0	7/14/14	A. Flores	Original document.
1-1	11/18/15	A. Flores	Updated LaneConfig Installation and User Guide references.
1-2	3/24/16	A. Flores	UL 2593 and CSA C22.2 #247 Certifications
1-3	6/28/16	D. Bohannon	Updated sections on changing network configuration and date/time settings related to Amanda boards.
1-4	8/3/16	A. Flores	Removed UL325 Listing. Updated GateKeeper section to include web-based functionality.
1-5	3/13/20	C. Maynez	Updated all User Status Light images.
1-6	6/25/20	C. Maynez	Terminology update.

